

# *high* life

QuickClick® *collection*

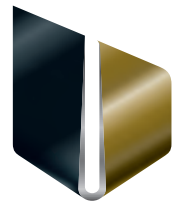

german  
brand  
award  
19  
winner

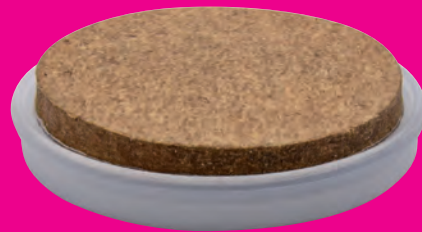

Green  
Product  
Award  
Selection  
2019

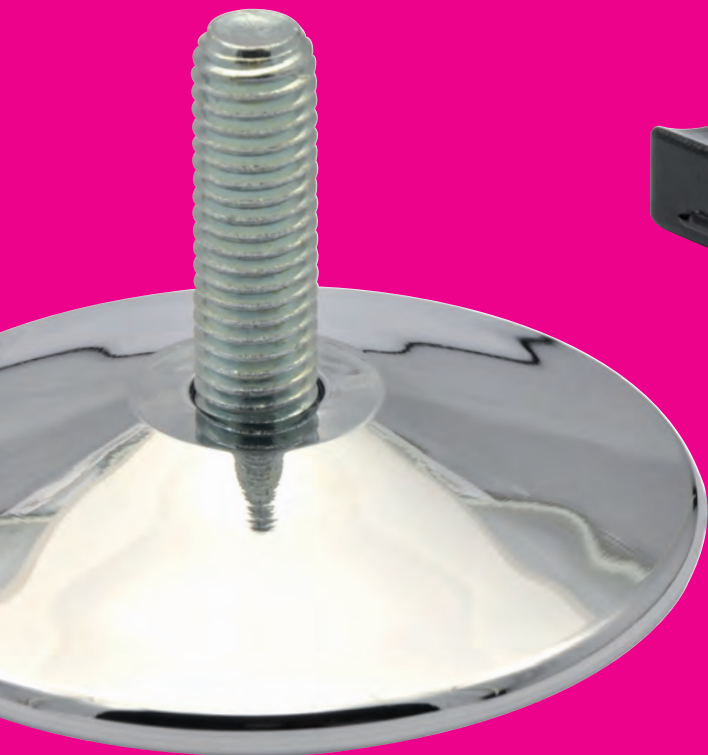













*design yourself*

**WAGNER®**

# Erklärungen der Abkürzungen und Piktogramme

Explanation of abbreviations and pictograms

Explication des abréviations et des pictogrammes













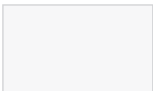





 <p><b>Ø mm</b></p>	<p><b>Durchmesser / Gleiteinsatz</b>                  Diameter / Insert                  Diamètre / Insert</p>		<p><b>Rohrdurchmesser außen</b>                  External tube diameter                  Diamètre du tube extérieur</p>
	<p><b>Höhe</b>                  Height                  Hauteur</p>		<p><b>Rohrdurchmesser innen</b>                  Inner tube diameter                  Diamètre du tube intérieur</p>
	<p><b>Rohrdurchmesser</b>                  Tube diameter                  Diamètre du tube</p>		<p><b>Rohrdurchmesser innen/außen</b>                  Inner/external tube diameter                  Diamètre du tube intérieur/extérieur</p>
	<p><b>Grundfläche Basis</b>                  Dimensions of base                  Dimension de la base</p>		<p><b>Innenabmessung</b>                  Inner dimensions                  Dimension de la base</p>
	<p><b>Max. Innenmaß</b>                  Max. inner measurement                  Dimensions intérieures maximales</p>		
 <p><b>M x</b></p>	<p><b>Gewindemaß</b>                  Thread measurement                  Dimensions du filetage</p>		
 <p><b>Degree°</b></p>	<p><b>Grad</b>                  Degree                  Degré</p>		
	<p><b>Einsatz</b>                  Insert                  Insert</p>		
	<p><b>Farbe</b>                  Colour                  Couleur</p>		
<p><b>pcs.</b></p>	<p><b>Verpackungseinheit</b>                  Packing unit                  Unité d'emballage</p>		
<p><b>Code</b></p>	<p><b>Artikelnummer</b>                  Article number                  Numéro d'article</p>		
<p><b>EAN-Code                  4001073 ...</b></p>	<p><b>EAN 13-Code, 4001073 wird durch die 6 Ziffern der tabelle ergänzt</b>                  EAN 13-Code, 4001073 is completed by the 6 numbers listed in the table                  EAN 13-Code, 4001073 est complété par les 6 chiffres indiqués dans le tableau</p>		



## Erklärungen der Abkürzungen und Piktogramme

Explanation of abbreviations and pictograms

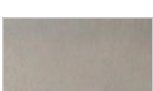
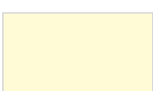
Explication des abréviations et des pictogrammes

	Einsatz auf... / Application on... / Utilisation sur...		Farbe / Colour / Couleur
	<b>anspruchsvollen Oberflächen - z. B. Parkett</b> highly delicate surfaces, e.g. parquet surfaces super-déliçats, par ex. parquet		<b>schwarz</b> black noir
	<b>empfindlichen Oberflächen - z. B. Laminat</b> sensitive surfaces, e.g. laminate surfaces sensibles - p. ex. stratifié		<b>weiß</b> white blanc
	<b>harten Oberflächen - z. B. Terrakotta</b> hard surfaces, e.g. terracotta surfaces dures - par ex. terre cuite		<b>braun</b> brown marron
	<b>glatten Oberflächen - z. B. Linoleum</b> smooth surfaces, e.g. linoleum surfaces lisses - par ex. linoléum		<b>beige</b> beige beige
	<b>allen unempfindlichen Oberflächen</b> all non-sensitive surfaces toutes les surfaces insensibles		<b>grün</b> green vert
	<b>weichen Oberflächen - z. B. Teppich</b> soft surfaces, e.g. carpet surfaces souples - par ex. tapis		<b>grau</b> grey gris
	<b>rauen Oberflächen - z. B. Holzplanken</b> rough surfaces, e.g. wooden planks surfaces rêches - par ex. planches en bois		<b>grau RAL7040</b> grey RAL7040 gris RAL7040
	<b>unebenen Oberflächen - z. B. Pflaster</b> uneven surfaces, e.g. cobblestones surfaces inégales - par ex. pavé		<b>chrom</b> chrome chrome
	<b>glatten Oberflächen - z. B. Marmor</b> smooth surfaces, e.g. marble surfaces lisses - par ex. marbre		<b>chrom-matt</b> matt-chrome chrome-mat
			<b>natur</b> nature nature
			<b>transparent</b> transparent transparent

\*Diese Basis wird grundsätzlich mit einem passenden Einsatz geliefert, kann jedoch auch mit jedem anderen QuickClick®-Einsatz kombiniert werden.

\*This base is supplied with a fitting insert, but it can also be combined with every other QuickClick® insert.

\*Cette base est livrée avec un insert adapté, peut toutefois être combiné avec tous autres types d'inserts QuickClick®.

\*\*Kompatibel mit Einsatz „DUO“ / \*\*Compatible with „DUO“ insert / \*\*Compatible avec insert „DUO“

Im Sinne technischen Fortschritts behalten wir uns Konstruktionsänderungen und die Verwendung anderer Materialien ausdrücklich vor. Katalogabbildungen und andere beschreibende Aussagen sind daher unverbindlich.

We reserve the right to make changes concerning construction and the use of other materials due to technical progress. Therefore pictures and article descriptions are not binding.









Dans le cas d'améliorations techniques, nous réservons le droit de modifier la construction ainsi que d'employer d'autres matériaux. Les images et les descriptions sont sans obligation.

# Inhaltsverzeichnis QuickClick® Collection

Contents QuickClick collection

Sommaire QuickClick collection

	<b>QuickClick® - das System</b> QuickClick® - the system QuickClick® - le système	<b>Seite</b> 6-17 page 6-17 page 6-17
	<b>Basis zum Anschrauben</b> Base for fasten on Base à visser	<b>Seite</b> 18-35 page 18-35 page 18-35
	<b>Basis zum Einstecken</b> Base for putting in Base à enficher	<b>Seite</b> 35-39 page 35-39 page 35-39
	<b>Basis zum Einstecken</b> Base for putting in Base à enficher	<b>Seite</b> 40-48 page 40-48 page 40-48
	<b>Basis zum Aufdrehen</b> Base for screw on Base à tourner	<b>Seite</b> 49-56 page 49-56 page 49-56
	<b>Basis zum Einstecken</b> Base for putting in Base à enficher	<b>Seite</b> 57-58 page 57-58 page 57-58
	<b>Basis zum Einstecken (Smart)</b> Base for putting in (Smart) Base à enficher (Smart)	<b>Seite</b> 58-66 page 58-66 page 58-66
	<b>Basis zum Einstecken</b> Base for putting in Base à enficher	<b>Seite</b> 67-74 page 67-74 page 67-74
	<b>Basis zum Einstecken (Filigrano)</b> Base for putting in (Filigrano) Base à enficher (Filigrano)	<b>Seite</b> 75-77 page 75-77 page 75-77
	<b>Basis zum Einstecken mit Absorber (Silencer)</b> Base for putting in with absorber (Silencer) Base à enficher avec absorbeur (Silencer)	<b>Seite</b> 78-85 page 78-85 page 78-85
	<b>Basis zum Einstecken</b> Base for putting in Base à enficher	<b>Seite</b> 86-91 page 86-91 page 86-91
	<b>Basis zum Einstecken für vorne und hinten</b> Base for putting in front and back Base à enficher de l'avant et arrière	<b>Seite</b> 92-94 page 92-94 page 92-94
	<b>Basis zum Einstecken</b> Base for putting in Base à enficher	<b>Seite</b> 94-98 page 94-98 page 94-98
	<b>Basis zum Einpressen</b> Base to press on Base à apposer	<b>Seite</b> 99-104 page 99-104 page 99-104
	<b>Sonderlösungen</b> Special solutions Solutions spéciales	<b>Seite</b> 105-109 page 105-109 page 105-109

	<b>Einsätze ULTRASOFT</b> Inserts ULTRASOFT Inserts ULTRASOFT	<b>Seite 112-118</b> page 112-118 page 112-118
	<b>Einsätze SOFT</b> Inserts SOFT Inserts SOFT	<b>Seite 119-120</b> page 119-120 page 119-120
	<b>Einsätze NATURAL</b> Inserts NATURAL Inserts NATURAL	<b>Seite 121-123</b> page 121-123 page 121-123
	<b>Einsätze SYNO</b> Inserts SYNO Inserts SYNO	<b>Seite 124-126</b> page 124-126 page 124-126
	<b>Einsätze HYPER</b> Inserts HYPER Inserts HYPER	<b>Seite 127-130</b> page 127-130 page 127-130
	<b>Einsätze SUPER</b> Inserts SUPER Inserts SUPER	<b>Seite 131-134</b> page 131-134 page 131-134
	<b>Einsätze BLACK</b> Inserts BLACK Inserts BLACK	<b>Seite 135-138</b> page 135-138 page 135-138
	<b>Einsätze EXTREME</b> Inserts EXTREME Inserts EXTREME	<b>Seite 139-140</b> page 139-140 page 139-140
	<b>Einsätze STOPP</b> Inserts STOPP Inserts STOPP	<b>Seite 141-144</b> page 141-144 page 141-144
	<b>Einsätze DUO</b> Inserts DUO Inserts DUO	<b>Seite 145-146</b> page 145-146 page 145-146
	<b>Zubehör</b> Accessories Accessoires	<b>Seite 147-149</b> page 147-149 page 147-149
	<b>Sets</b> Sets Sets	<b>Seite 150-151</b> page 150-151 page 150-151
	<b>QuickClick® - Ihr Erfolg</b> QuickClick® - your success QuickClick® - votre succès	<b>Seite 152-157</b> page 152-157 page 152-157





# *high* system

**Die patentierte Weltneuheit: QuickClick®** – das erste Gleit- und Stopp-System mit austauschbaren Einsätzen.

Basis nur 1 x am Möbel oder Objekt befestigen; je nach Bodenbelag den passenden Einsatz wählen und einfach einklicken; jeder Einsatz ist ohne spezielles Werkzeug jederzeit wechselbar! **Der erste Schutz für Möbel und Böden!**

***The patented world novelty: QuickClick®*** – the first slide and stop system with exchangeable inserts.

*Fasten base to furniture or object 1 x only; depending on floor surface select the suitable insert and simply click in; each application is easily exchangeable at any time without any special tools! **The first protection for furniture and floors!***

***La nouveauté mondiale brevétée : QuickClick®*** – le premier système de glissement et d'arrêt avec des inserts interchangeable.

*La base est fixée une seule fois au meuble ou à l'objet; selon le type de sol, choisir l'insert correspondant en le cliquant tout simplement; chaque insert peut être changé à tout moment sans outil spécifique ! **La première protection pour meubles et sols !***



**ULTRASOFT-Einsatz** – ultraweiche, hochstrapazierfähige Wollfilzqualität; wird ohne Klebstoff direkt im Formguss mit dem Kunststoff-Additiv verbunden; für hochsensible Böden

**ULTRASOFT-insert** – *ultra soft, highly duty wool felt quality; connects without adhesives directly in the plastic form; for highly sensitive floorings*

**Insert-ULTRASOFT** – *qualité de feutre en laine ultra-doux et particulièrement robuste ; amalgamée directement dans le moulage grâce aux additifs de matière plastique et sans colle ; pour les sols particulièrement sensitifs*

**SOFT-Einsatz** – aus flaumweichem Wollfilz; wird ohne Klebstoff direkt im Formguss mit dem Kunststoff-Additiv verbunden; schützt und pflegt alle hochsensiblen Oberflächen

**SOFT-insert** – *from soft wool felt; connects without adhesives directly in the plastic form; protects and maintains all highly sensitive surfaces*

**Insert-SOFT** – *en feutrine très douce; amalgamée directement dans le moulage grâce aux additifs de matière plastique et sans colle; protège et entretient toutes les surfaces très sensibles*

**NATURAL-Einsatz** – aus abriebfestem Naturfilz; extrem langlebig; wird ohne Klebstoff direkt im Formguss mit dem Kunststoff-Additiv verbunden; für alle harten Böden

**NATURAL-insert** – *from resistant friction free natural felt; extremely durable; connects without adhesives directly in the plastic form; for all hard surfaces*

**Insert-NATURAL** – *en feutre résistant à l'usure; longévité extrême; amalgamée directement dans le moulage grâce aux additifs de matière plastique et sans colle; pour tous sols durs*

# high

**SYNO-Einsatz** – neuartiges, natürliches Spezial-Fasergemisch; extrem abriebfest, feuchtigkeitsabweisend und schalldämpfend

**SYNO-insert** – *novel, natural special fibre mixture; extremely abrasion proof, humidity repellent and sound damping*

**Insert-SYNO** – *nouvel, naturel mélange de fibres spécial ; extrêmement résistant à l'abrasion, hydrofuge et absorbant les sons*

**HYPER-Einsatz** – aus hochgleitfähigem thermoplastischem Kunststoff; für unempfindliche Beläge im Innenbereich; auch für Werkstatt- und Industrieböden geeignet

**HYPER-insert** – *made of highly-slidable thermoplastic; for non-sensitive floorings in the indoor area; also fitting for floorings in workshops and factories*

**Insert-HYPER** – *en matière thermoplastique ultra-coulissante ; pour les revêtements insensibles à l'intérieur ; aussi approprié pour les sols dans les ateliers et les usines*

**SUPER-Einsatz** – aus hochtechnischem POM-Kunststoff (Einsatz in der Weltraumtechnik); sehr gute Gleiteigenschaften, für alle weichen Beläge

**SUPER-insert** – *from high-technical POM plastic (applied in space technology); very good sliding properties; for all soft surfaces*

**Insert-SUPER** – *en plastique high tech POM (utilisé dans la construction spatiale) ; très bons propriétés de glissement; pour tous revêtements souples*





# material

**BLACK-Einsatz** – aus wetter- und temperaturbeständigem Kunststoff; hochabriebfest; für alle robusten Beläge im Innen- und Außenbereich

**BLACK-insert** – made of weather-proof and temperature-resistant plastic; highly abrasion-resistant; for all robust floorings in the indoor and outdoor area

**Insert-BLACK** – en plastique traité tous temps et température ; résistant à l'abrasion ; pour tous les sols robustes à l'intérieur et à l'extérieur

**EXTREME-Einsatz** – aus extrem strapazierfähigem Polymer; optimale Gleiteigenschaften auf unebenen Böden im Außenbereich

**EXTREME-insert** – made of extremely sturdy polymer; optimal slide properties on uneven floors in the outdoor area

**Insert-EXTREME** – en polymère extrêmement solide ; des propriétés optimales sur les sols inégales à l'extérieur

**STOPP-Einsatz** – aus gleitresistentem Elastomere; äußerst verschleißarm; für den sicheren Stopp-Effekt; kein Wegrutschen mehr auf allen glatten Oberflächen

**STOPP-insert** – from slide resistant elastomer; extremely wear resistant; for the safe stop effect; no more slipping away on all smooth surfaces

**Insert-STOPP** – en élastomère résistant aux glissements; usure extrêmement faible; pour un effet stop assuré; plus aucun dérapage sur toutes surfaces lisses

**ULTRASOFT** – der ultraweiche Gleiteinsatz; besonders geräuscharm; maximaler Schutz für hochanspruchsvolle Böden wie z. B. Parkett, Laminat, Fliese

**ULTRASOFT** – the ultra soft slide insert; particularly low-noise; maximum protection for highly delicate floorings such as parquet, laminate, tiles

**ULTRASOFT** – l'insert glissant ultra tendre; particulièrement silencieux; protection maximale pour les sols super-déliçats comme par ex. parquet, stratifié, carrelages

**SOFT** – der Gleiteinsatz für empfindliche Bodenbeläge wie z.B. Parkett, Laminat, Marmor, Kork oder Feinkeramikfliese

**SOFT** – the slide insert for sensitive flooring material e.g. parquet, laminate, marble, cork or ceramic tiles

**SOFT** – l'insert pour les revêtements de sols sensibles comme par ex. parquet, stratifié, marbre, liège ou carrelage émaillé

**NATURAL** – der Gleiteinsatz für alle harten, glatten Oberflächen wie z.B. Natur- und Mosaikstein, Terrakotta-Fliese, PVC, Linoleum oder Holzdielen

**NATURAL** – the slide insert for all hard, smooth surfaces e.g. natural and mosaic stone, terracotta tiles, PVC, linoleum or wooden floor boards

**NATURAL** – l'insert pour toutes les surfaces dures et lisses comme par ex. les pierres naturelles, mosaïques, carrelage en terre cuite, PVC, linoléum ou planchers en bois

# high

**SYNO** – der geschmeidige Spezialgleiter zum Schutz und Erhalt besonders beanspruchter Bodenbeläge z.B. im Projekt- und Gastronomie-Bereich

**SYNO** – the smooth special glide for the protection and preservation of strongly stressed floorings, e.g. in the field of contract and hospitality

**SYNO** – le patin spécial souple pour la protection et la préservation des sols particulièrement sollicités, p. ex. dans les domaines spécifiques et de la gastronomie

**HYPER** – der Spezial-Gleiteinsatz für extrem leichte Beweglichkeit auf elastischen und harten, glatten Böden sowie textilen Belägen

**HYPER** – the special slide insert for extremely easy mobility on elastic and hard, smooth floors as well as on textile floorings

**HYPER** – l'insert glissant spécial pour une mobilité extrêmement facile sur les revêtements élastiques et les sols durs, lisses aussi bien que sur les tapis

**SUPER** – der Gleiteinsatz für weiche und raue Bodenflächen wie z. B. Teppich, Sisal, Nadel filz, Linoleum, Beton oder Metall

**SUPER** – slide insert for soft and rough floor surfaces e.g. carpet, sisal, needle wool, linoleum, concrete or metal

**SUPER** – l'insert glissant pour les revêtements de sols souples et inégaux comme par ex. tapis, sisal, moquette, linoléum béton et métal



# change

**BLACK** – der Gleiteinsatz mit hervorragenden Gleit- und Schutzeigenschaften im Außenbereich, z. B. für Fliesen und Holzplanken

**BLACK** – the slide insert with excellent slide and care properties in the outdoor area, e.g. for tiles and wooden planks

**BLACK** – l'insert glissant avec des propriétés excellentes de glissement et de la protection dans l'extérieur, p. ex. pour les carrelages et les planches en bois

**EXTREME** – hochbelastbarer Gleiteinsatz, strapazierfähig und abriebfest; für harte, unebene Beläge im Innen- und Außenbereich

**EXTREME** – highly durable slide insert, highly duty and abrasion resistant; for hard, uneven floorings in the indoor and outdoor area

**EXTREME** – insert glissant haut-résistant, solide et résistant à l'abrasion ; pour les revêtements durs, inégales pour un usage à l'intérieur et à l'extérieur

**STOPP** – der Sicherheits-Einsatz mit dem Stopp-Effekt für alle glatten, rutschigen Beläge wie z. B. Marmor, Keramikfliese, Naturstein, Holzböden

**STOPP** – the safety insert with the stop effect for all smooth, slippery surfaces e.g. marble, ceramic tiles, natural stone, wooden floors

**STOPP** – l'insert de sécurité avec effet stop pour les revêtements lisses et glissants comme par ex. marbre, carrelage, pierre naturelle, bois

Bei Bodenwechsel oder Verschleiss: **alten Einsatz ausklicken** ...

*In case of floor surface change or wear: **click old insert out** ...*

*En cas de changement de sol ou d'usure: **dé-cliquez l'ancien insert** ...*



... neuen Einsatz einklicken, fertig!

... *click new insert in, finished!*

... *cliquez le nouveau, fini!*



# high awards

**QuickClick® ist ausgezeichnet** - und zwar vielfach. Als einziger Möbelgleiter der Welt wurde das QuickClick Gleit- und Stopp-System mit seinen ideenreichen Varianten von den wichtigsten deutschen Design-Institutionen prämiert.

Zum Beispiel vom Rat für Formgebung, der den „German Design Award“ vergibt. QuickClick wurde aber auch für den „German Brand Award“ ausgezeichnet – als außergewöhnlich konsequent und erfolgreich geführte Marke.

*QuickClick® is awarded, in fact in many cases. As world's single furniture slider, the QuickClick slide and stop system with its creative varieties has been honoured by the most important German design institutions.*

*From the German Design Council, for example, that announces the "German Design Award". Furthermore, QuickClick has been awarded with the "German Brand Award" – as an extraordinary consequently and successfully led brand.*

*QuickClick® est de première force, à savoir d'une manière multiple. Comme seul patin du monde pour meubles, la système QuickClick avec ses variantes plein d'idées à été primée par les plus importants institutions de dessin allemands.*

*Du Conseil Allemand du Conception, par exemple, qui décerne le « German Design Award ». En plus, QuickClick a été distingué pour le « German Brand Award » – comme marque guidé particulièrement conséquent et avec succès .*

Bei Bodenwechsel:  
**DUO-Einsatz ausklicken ...**

*In case of floor surface  
change : **click DUO-  
insert out ...***

*En cas de changement  
de sol : **enlevez l'insert  
DUO ...***



... wenden, einklicken, fertig!

... turn the insert, click in,  
finished!

... tournez-le, connectez-le  
et ça y est !





# *high* solution

**Der QuickClick® DUO ist einmalig.** Denn er ist der erste wendbare Möbelgleiter und funktioniert als 2in1-Lösung: ein Gleiteinsatz mit zweifachem Schutz für robuste, weiche Böden und für empfindliche, harte Böden – einfach ausklicken, wenden und wieder einklicken!

Diese clevere Idee ist „made in Germany“ und wurde bei internationalen Wettbewerben mehrfach ausgezeichnet.

**The QuickClick® DUO is unique.** It's because it is the first reversible furniture glider and it works as a 2in 1-solution: one gliding insert with double protection for robust, smooth floorings and for sensitive, soft floorings – just click it out, turn it and click it in again!

This clever idea is “made in Germany” and has been awarded several times within international competitions.

**L'insert QuickClick® DUO est unique.** Car il est le premier patin de meuble qui peut être tourné et fonctionne comme une solution 2 en 1 : Un insert avec double protection pour des sols robustes, mous et pour des sols sensibles, durs – il faut simplement l'enlever, tourner et reconecter !

Cette idée astucieuse est « made in Germany » et était primée à plusieurs reprises auprès des concours internationaux.



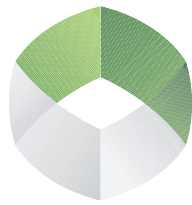

**Green  
Product Award**  
Selection 2019

# *eco* friendly

QuickClick® ist nicht nur ein flexibles System, sondern auch eine nachhaltig gute Idee. Denn QuickClick-Komponenten haben eine sehr hohe Lebensdauer und bieten Verbrauchern, Industrie und Umwelt ein Optimum an Komfort und Werterhaltung.

Besonders umweltschonend: Die neuen ECOFRIENDLY-Varianten werden aus einem speziellen Bio-Compound gefertigt, das bis zu 80 Prozent aus nachwachsenden Rohstoffen besteht.

*QuickClick® is not only a flexible system, but also a sustainably good idea, because QuickClick components have a very long lifetime and offer an optimum of comfort and value retention to consumers, industry and environment.*

*Particularly environmentally friendly: the new ECOFRIENDLY varieties are made out of a special bio compound that consists with a content of up to 80 percent of renewable raw materials.*

*QuickClick® n'est pas seulement un système flexible mais aussi une idée durablement bonne, parce que les composants QuickClick ont une très longue durée de vie et offrent un optimum de confort et maintien de la valeur.*

*Particulièrement respectueux de l'environnement : les nouvelles variantes ECOFRIENDLY sont fabriquées d'une bio composée spéciale qui se compose de matières premières renouvelables, avec une proportion de jusqu'à 80 % .*

Basis „SLIM“ zum Anschrauben an z.B. Holzmöbel  
 Base „SLIM“ for screwing on e.g. wooden furniture  
 Base „SLIM“ à visser par ex. aux meubles en bois

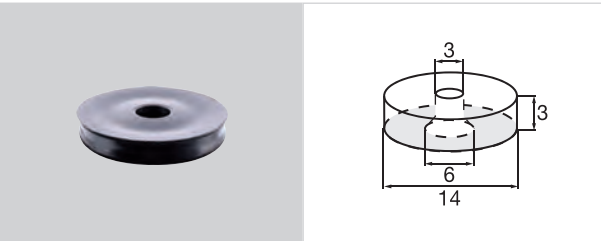

	Ø mm					pcs.	Code	EAN-Code 4001073 ...
	17					100	15 8117 01	...298260



	Ø mm					pcs.	Code	EAN-Code 4001073 ...
	17					100	16 8117 01	...024784

Basis „SILENCER SLIM“ zum Anschrauben an z.B. Holzmöbel  
 Base „SILENCER-SLIM“ for screwing on e.g. wooden furniture  
 Base „SILENCER-SLIM“ à visser par ex. aux meubles en bois

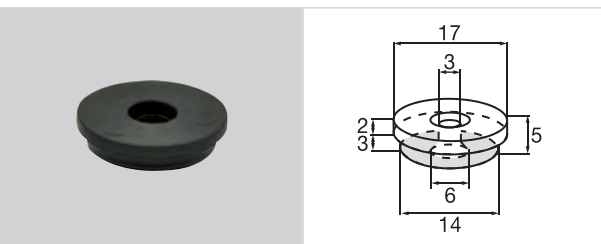

	Ø mm					pcs.	Code	EAN-Code 4001073 ...
	17					100	15 8123 01	...324662



Absorber für „SILENCER SLIM“  
 Absorber for „SILENCER-SLIM“  
 Absorbeur pour „SILENCER-SLIM“



	Ø mm					pcs.	Code	EAN-Code 4001073 ...
	17					100	15 0950 01	...327380

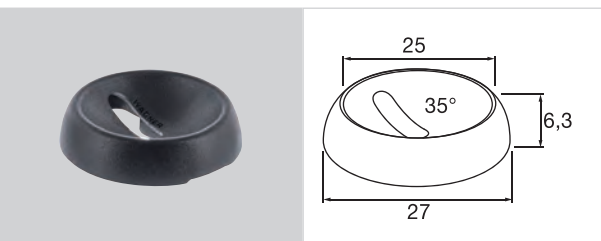







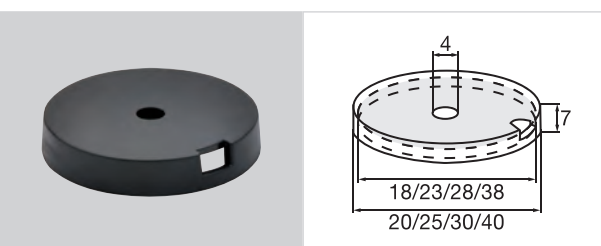















Basis „SWING“ für Kugelform zum Anschrauben an z.B. Holzmöbel  
 Base „SWING“ for ball shape for screwing on e.g. wooden furniture  
 Base „SWING“ sphérique à visser par ex. aux meubles en bois



	Ø mm					pcs.	Code	EAN-Code 4001073 ...
	25					100	16 8118 01	...005691
	25					100	16 8119 01	...396157







Basis „DUO“ zum Anschrauben an z.B. Holzmöbel  
 Base „DUO“ for screwing on e.g. wooden furniture  
 Base „DUO“ à visser par ex. aux meubles en bois

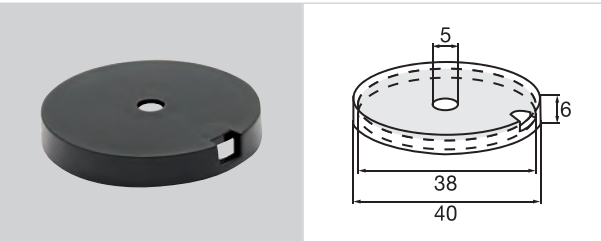

	Ø mm					pcs.	Code	EAN-Code 4001073 ...
	20					100	15 8720 01	...000528
	25					100	15 8725 01	...000627
	30					100	15 8018 01	...007046
	40					100	15 8941 01	...050202
	20					100	15 8820 01	...001228
	25					100	15 8825 01	...001327
	30					100	15 8833 01	...007350
	40					100	15 8942 01	...050226
	20					100	15 8920 01	...001525
	25					100	15 8925 01	...001624
	30					100	15 9228 01	...398007
	40					100	15 8943 01	...050233
	20					100	15 9220 01	...490008
	25					100	15 9225 01	...492057
	30					100	15 9229 01	...398014
	40					100	15 9239 01	...492118
	20					100	15 9020 01	...001822
	25					100	15 9025 01	...001921
	30					100	15 9226 01	...594966
	40					100	15 8940 01	...050219
	25					100	15 9120 01	...001914
	30					100	15 8013 01	...397949
	40					100	15 9122 01	...004557









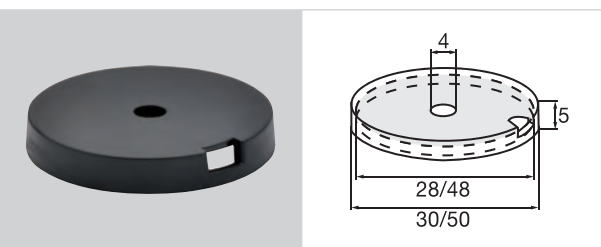



Basis „DUO“ zum Anschrauben an z.B. Holzmöbel  
 Base „DUO“ for screwing on e.g. wooden furniture  
 Base „DUO“ à visser par ex. aux meubles en bois



	Ø mm					pcs.	Code	EAN-Code 4001073 ...
	40					100	15 8541 01	...050141
	40					100	15 8841 01	...594973
	40					100	15 9238 01	...594980
	40					100	15 8945 01	...595062
	40					100	15 8944 01	...594997

Basis rund zum Anschrauben an z.B. Holzmöbel  
 Round base for screwing on e.g. wooden furniture  
 Base ronde à visser par ex. aux meubles en bois



	Ø mm					pcs.	Code	EAN-Code 4001073 ...
	30					100	15 8730 01	...001129
	50					100	15 8059 01	...047004
	30					100	15 8830 01	...001426
	50					100	15 8259 01	...047035
	30					100	15 8930 01	...001723
	50					100	15 8459 01	...047028
	30					100	15 9230 01	...492101
	50					100	15 9250 01	...492125
	30					100	15 9030 01	...002027
	50					100	15 8659 01	... 047011
	30					100	15 9121 01	...002218
	50					100	15 9123 01	...004656

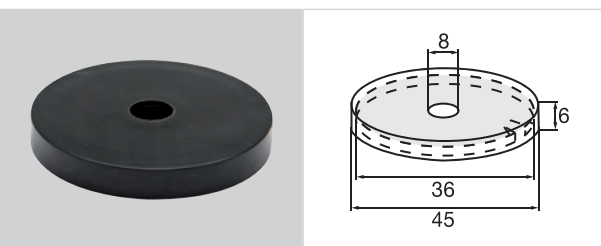

	Ø mm					pcs.	Code	EAN-Code 4001073 ...
	40					100	15 8542 01	...492200





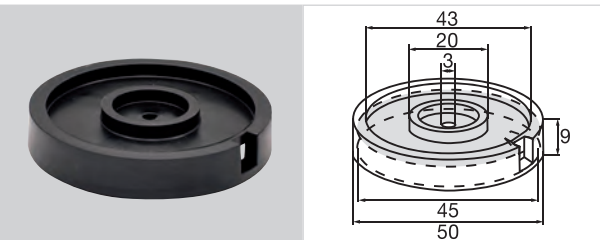





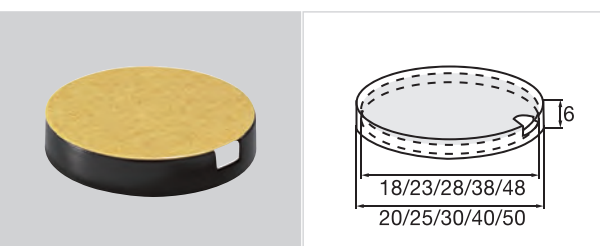









Basis rund zum Anschrauben an z.B. Holzmöbel  
 Round base for screwing on e.g. wooden furniture  
 Base ronde à visser par ex. aux meubles en bois



	Ø mm					pcs.	Code	EAN-Code 4001073 ...
	50					100	15 8070 01	...027020

Basis rund selbstklebend für alle glatten, ebenen Oberflächen  
 Round base self-adhesive for all smooth, even surfaces  
 Base ronde auto-adhésive pour toutes les surfaces lisses et égales



	Ø mm					pcs.	Code	EAN-Code 4001073 ...
	20					100	15 8721 01**	...050042
	25					100	15 8726 01**	...050059
	30					100	15 8732 01	...050103
	30					100	15 8733 01**	...072006
	40					100	15 8740 01**	...050301
	50					100	15 8061 01	...049756
	20					100	15 8821 01**	...050110
	25					100	15 8826 01**	...050127
	30					100	15 8832 01	...050134
	40					100	15 8840 01**	...050318
	50					100	15 8261 01	...049800
	20					100	15 8731 01**	...057454
	25					100	15 8734 01**	...057522
	30					100	15 9031 01	...002119
	50					100	15 8661 01	...049824
	20					100	15 8729 01	...053548
	50					100	15 8461 01	...049817

Basis „GLUE“ selbstklebend für alle glatten, ebenen Oberflächen  
 Base „GLUE“ self-adhesive for all smooth, even surfaces  
 Base „GLUE“ auto-adhésive pour toutes les surfaces lisses et égales

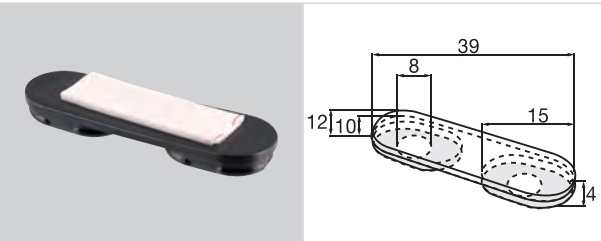



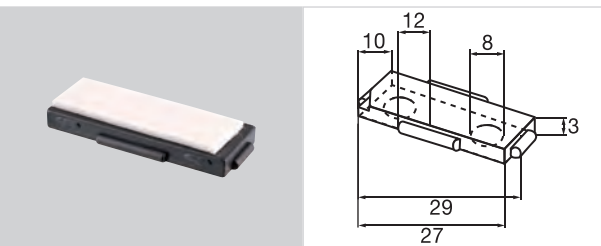

	Ø mm					pcs.	Code	EAN-Code 4001073 ...
	39x12					100	16 9449 01	...005097



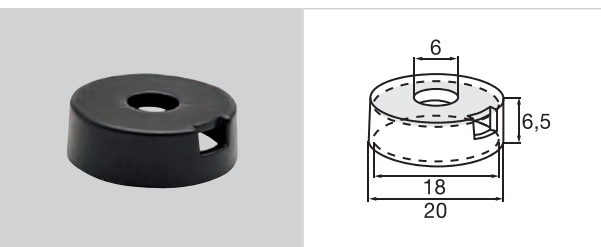



	Ø mm					pcs.	Code	EAN-Code 4001073 ...
	27x10					100	16 9450 01	...398151

Basis rund zum Anschrauben an z.B. Holzmöbel  
 Round base for screwing on e.g. wooden furniture  
 Base ronde à visser par ex. aux meubles en bois

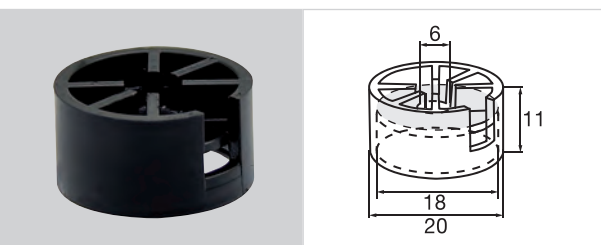





	Ø mm					pcs.	Code	EAN-Code 4001073 ...
	20					100	15 8828 01**	...006957
	20					100	15 8827 01**	...006742

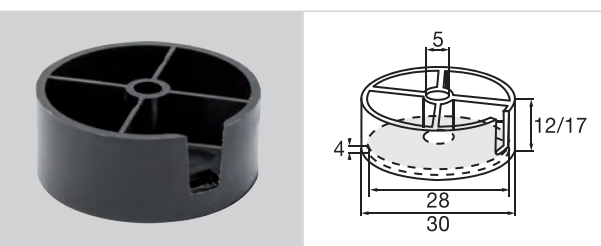





	Ø mm					pcs.	Code	EAN-Code 4001073 ...
	20					100	15 8823 01**	...005059
	20					100	15 8822 01**	...004854



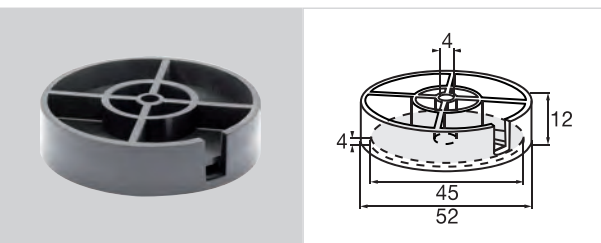





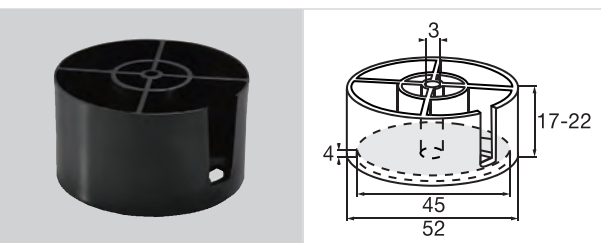

	Ø mm	↑ ↓				pcs.	Code	EAN-Code 4001073 ...
	30	12				100	15 8131 01	...490053
	30	17				100	15 8133 01	...396652
	30	12				100	15 8132 01	...299786
	30	17				100	15 8134 01	...396706

Basis rund zum Anschrauben an z.B. Holzmöbel  
 Round base for screwing on e.g. wooden furniture  
 Base ronde à visser par ex. aux meubles en bois



	Ø mm					pcs.	Code	EAN-Code 4001073 ...
	50					100	15 8151 01	...490459
	50					100	15 8152 01	...053005



	Ø mm	↑ ↓					pcs.	Code	EAN-Code 4001073 ...
	50	17					100	15 8153 01	...397819
	50	20					100	15 8162 01	...397857
	50	22					100	15 8160 01	...397833
	50	17					100	15 8154 01	...397826
	50	20					100	15 8163 01	...397901
	50	22					100	15 8161 01	...397840

Basis rund zum Anschrauben an z.B. Holzmöbel  
 Round base for screwing on e.g. wooden furniture  
 Base ronde à visser par ex. aux meubles en bois

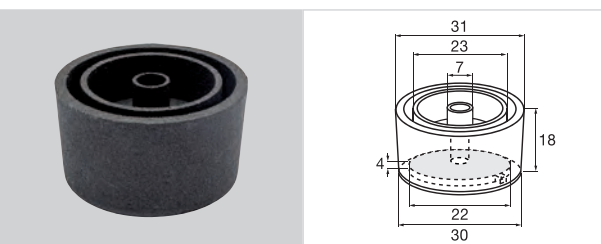

	Ø mm					pcs.	Code	EAN-Code 4001073 ...
	25					100	15 8818 01**	...398113



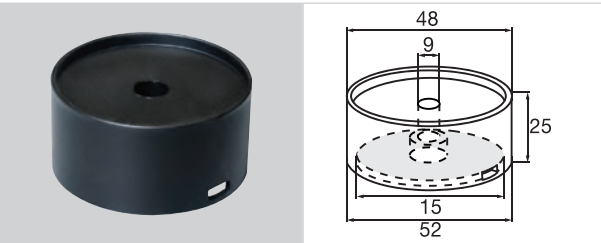

Basis/Adapter zur Verlängerung rund zum Anschrauben  
an z.B. Holzmöbel

Round base/adapter for extension for screwing on e.g. wooden furniture  
Base/adaptateur pour prolongement ronde à visser par ex. aux meubles  
en bois

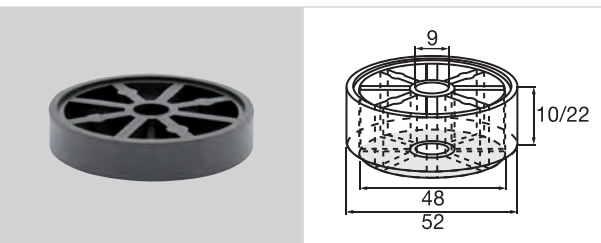

	Ø mm					pcs.	Code	EAN-Code 4001073 ...
	50					100	15 8166 01	...310894





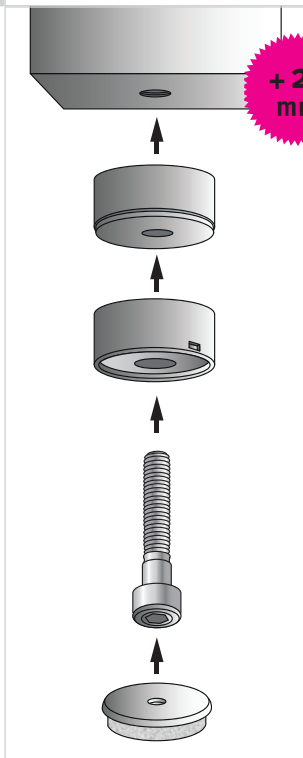

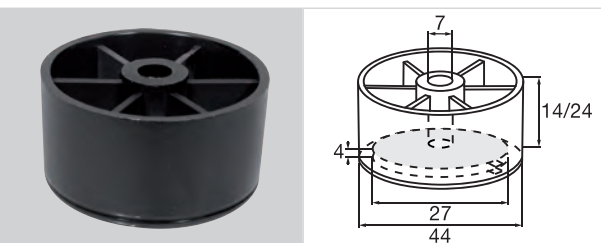

	Ø mm					pcs.	Code	EAN-Code 4001073 ...
	50	10				100	15 8168 01	...324181
	50	22				100	15 8167 01	...310962









Basis „LOUNGE“ zum Anschrauben an z.B. Polstermöbel  
 Base „LOUNGE“ for screwing on e.g. upholstered furniture  
 Base „LOUNGE“ à visser par ex. aux meubles rembourrés

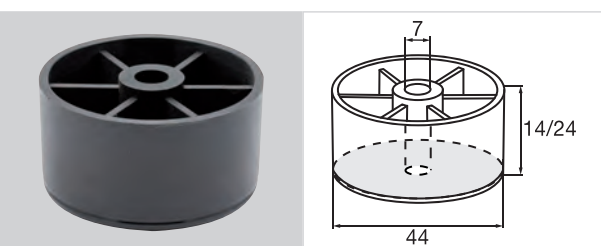

	Ø mm					pcs.	Code	EAN-Code 4001073 ...
	30/40	14				100	16 0402 01**	...053616
	30/40	24				100	16 0403 01**	...053623
	30/40	14				100	16 0412 01**	...053753
	30/40	24				100	16 0413 01**	...053807





Basis „EASY LOUNGE“ zum Anschrauben an z.B. Polstermöbel  
 Base „EASY LOUNGE“ for screwing on e.g. upholstered furniture  
 Base „EASY LOUNGE“ à visser par ex. aux meubles rembourrés

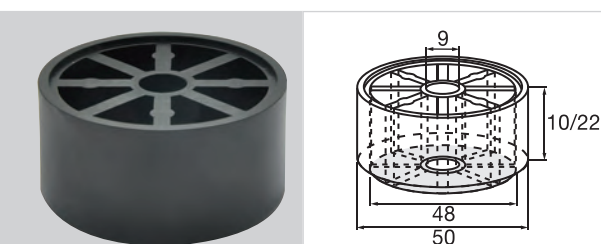

	Ø mm					pcs.	Code	EAN-Code 4001073 ...
	40	14				100	16 0406 01	...053654
	40	24				100	16 0407 01	...053708
	40	14				100	16 0416 01	...053838
	40	24				100	16 0417 01	...053845

Adapter zur Verlängerung rund für Basis „LOUNGE“/„EASY LOUNGE“  
 Round adapter for extension of base „LOUNGE“/„EASY LOUNGE“  
 Adaptateur rond pour prolongement de base „LOUNGE“/„EASY LOUNGE“



	Ø mm					pcs.	Code	EAN-Code 4001073 ...
	50	10				100	15 8171 01	...331066
	50	22				100	15 8170 01	...330182

Basis „JUSTUS LOUNGE“ zum Anschrauben an z.B. Polstermöbel  
 Base „JUSTUS LOUNGE“ for screwing on e.g. upholstered furniture  
 Base „JUSTUS LOUNGE“ à visser par ex. aux meubles rembourrés

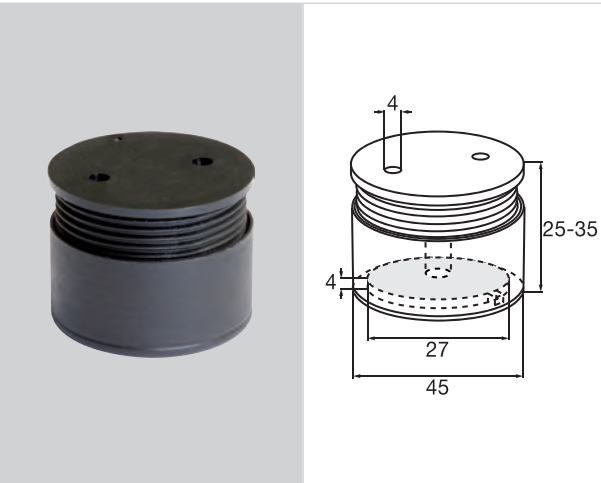

	Ø mm					pcs.	Code	EAN-Code 4001073 ...
	30/40					100	16 9070 01**	...006285

Basis „JUSTUS LOUNGE“ mit Anschraubplatte zum Anschrauben an z.B. Polstermöbel  
 Base „JUSTUS LOUNGE“ with screw-on plate for screwing on e.g. upholstered furniture  
 Base „JUSTUS LOUNGE“ avec platine à visser par ex. aux meubles rembourrés

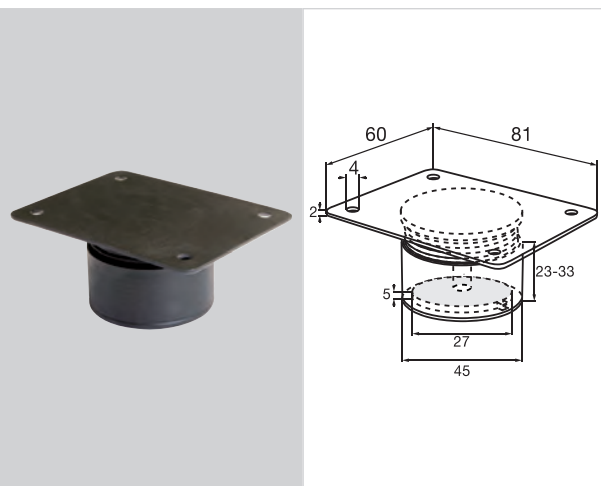

	Ø mm					pcs.	Code	EAN-Code 4001073 ...
	30/40					100	16 9071 01**	...200737







Basis „EQUALIZER“ zum Anschrauben - automatischer Niveausgleich!

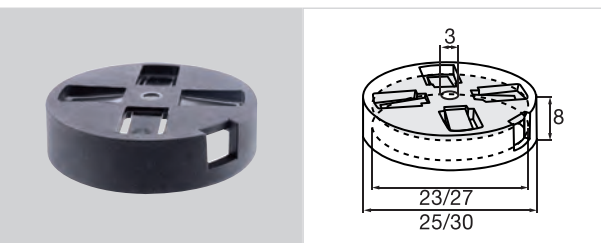

Base „EQUALIZER“ for screwing - automatic levelling function!

Base „EQUALIZER“ à visser - compensation de niveau automatique!

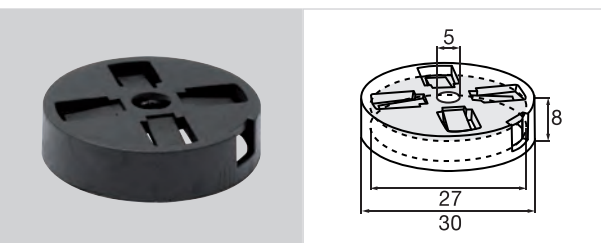

	Ø mm					pcs.	Code	EAN-Code 4001073 ...
	25					100	15 8836 01**	...530995
	30					100	15 8016 01**	...007053
	30					100	15 8834 01**	...013047
	30					100	15 8072 01**	...022759



	Ø mm					pcs.	Code	EAN-Code 4001073 ...
	30					100	15 8004 01**	...014013
	50					100	15 8009 01**	...053135

Basis „EQUALIZER“ zum Einstecken - automatischer Niveausgleich!

Base „EQUALIZER“ for inserting - automatic levelling function!

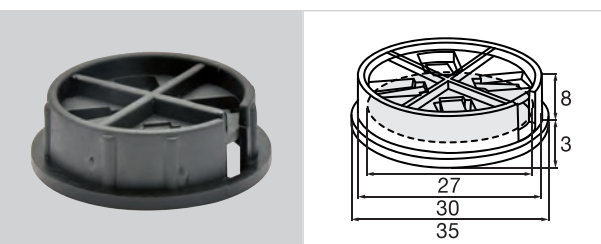

Base „EQUALIZER“ à enficher - compensation de niveau automatique!





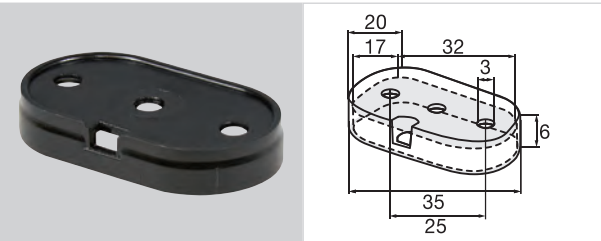



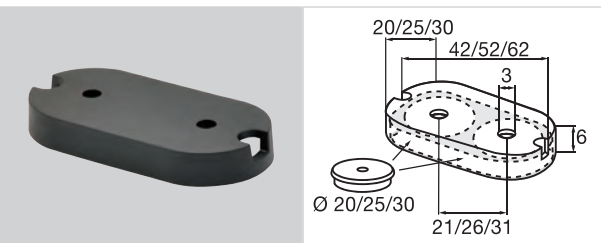

	Ø mm					pcs.	Code	EAN-Code 4001073 ...
	30	35/31				100	16 8016 01**	...022742

Basis oval/eckig zum Anschrauben an z.B. Holz-/Stahlrohrmöbel  
 Oval/square base for screwing on e.g. wooden/steel furniture  
 Base ovale/rectangulaire à visser par ex. aux meubles en bois/acier



	Ø mm					pcs.	Code	EAN-Code 4001073 ...
	35x20					100	15 9400 01	...298970
	35x20					100	15 9401 01	...298987



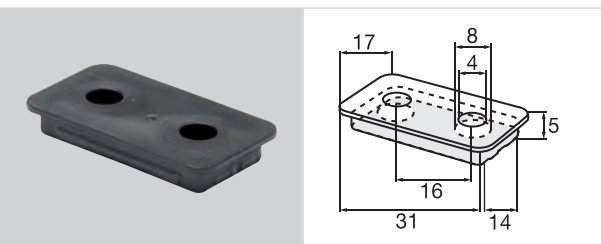

	Ø mm					pcs.	Code	EAN-Code 4001073 ...
	20					100	15 9460 01	...299090
	25					100	15 9461 01	...299168
	30					100	15 9462 01	...299175
	20					100	15 9463 01	...299182
	25					100	15 9464 01	...299199
	30					100	15 9465 01	...299267

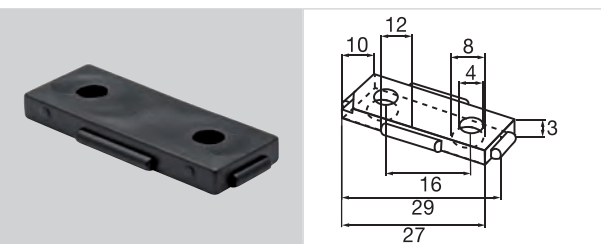

	Ø mm					pcs.	Code	EAN-Code 4001073 ...
	31x17					100	15 9489 01	...311860



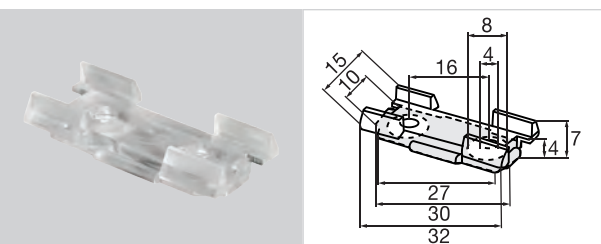

	Ø mm					pcs.	Code	EAN-Code 4001073 ...
	32x15					100	15 9450 01	...300796
	32x15					100	15 9451 01	...309263



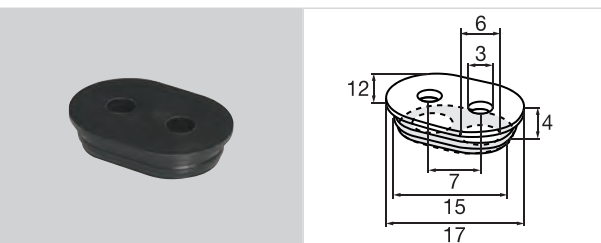

	Ø mm					pcs.	Code	EAN-Code 4001073 ...
	32x15	10				100	15 9452 01	...309195

Basis oval zum Anschrauben an z.B. Holz-/Stahlrohrmöbel  
 Oval base for screwing on e.g. wooden-/steel tube furniture  
 Base ovale à visser par ex. aux meubles en bois / acier

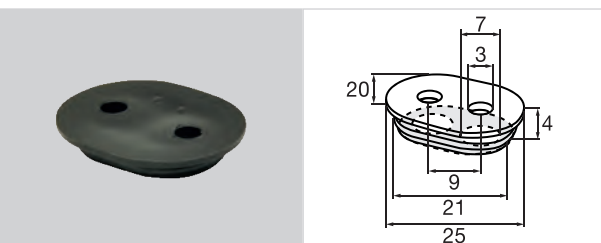

 Ø mm	pcs.	Code	EAN-Code 4001073 ...
17x12	100	15 9458 01	...309089
17x12	100	15 9258 01	...309171



 Ø mm	pcs.	Code	EAN-Code 4001073 ...
20x25	100	15 9495 01	...053050
20x25	100	15 9497 01	...053159

Basis eckig zum Anschrauben an z.B. Polstermöbel  
 Square base for screwing on e.g. upholstered furniture  
 Base rectangulaire à visser par ex. aux meubles rembourrés

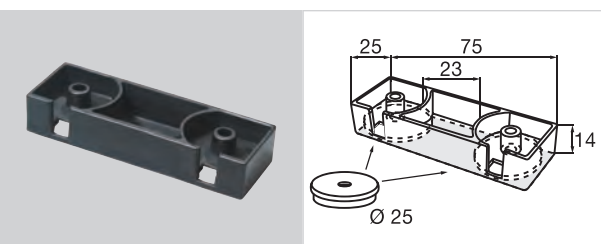

 Ø mm	pcs.	Code	EAN-Code 4001073 ...
25	100	15 9486 01	...396607

Kundenspezifischer Artikel hergestellt für **hülsta**  
 This article is produced exclusively for  
 Article spécifique fabriqué pour

Basis eckig zum Anschrauben für Fußkreuze  
 Square base for screwing on cross tubes  
 Base carrée à visser aux piètements à branches

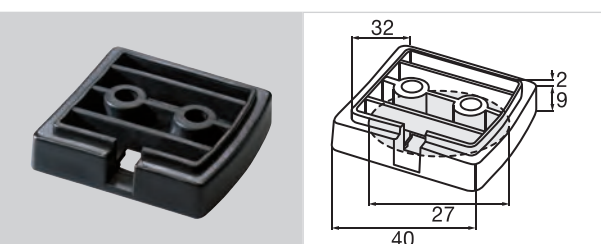





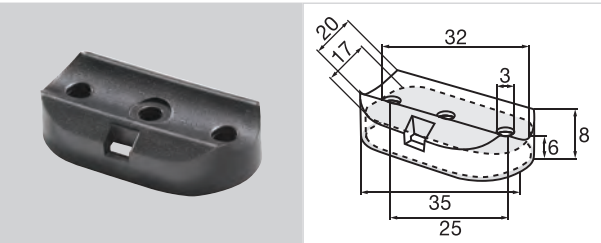

 Ø mm	pcs.	Code	EAN-Code 4001073 ...
30	100	15 9094 01	...197303





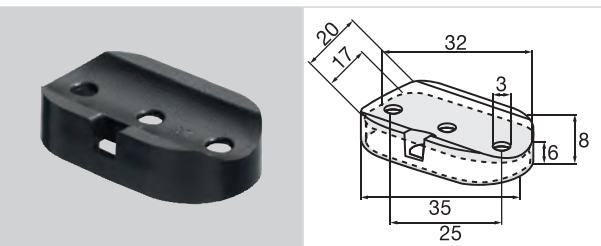

Kundenspezifischer Artikel hergestellt für **brunner**  
 This article is produced exclusively for  
 Article spécifique fabriqué pour

Basis oval zum Anschrauben an z.B. Rundrohre  
 Oval base for screwing on e.g. round tubes  
 Base ovale à visser par ex. aux tubes ronds









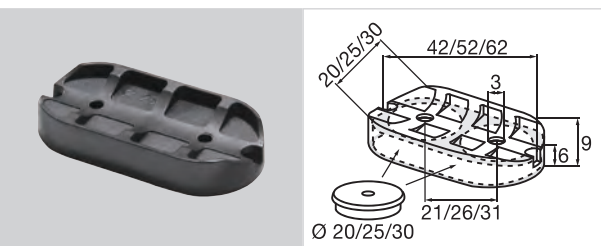







	Ø mm					pcs.	Code	EAN-Code 4001073 ...
	35x20	12				100	15 9408 01	...306699
	35x20	14				100	15 9410 01	...301489
	35x20	12				100	15 9409 01	...306767
	35x20	14				100	15 9411 01	...306682



	Ø mm					pcs.	Code	EAN-Code 4001073 ...
	35x20	20				100	15 9420 01	...298994
	35x20	25				100	15 9440 01	...299076
	35x20	20				100	15 9421 01	...299069
	35x20	25				100	15 9441 01	...299083
	35x20	25				100	15 9442 01	...317176









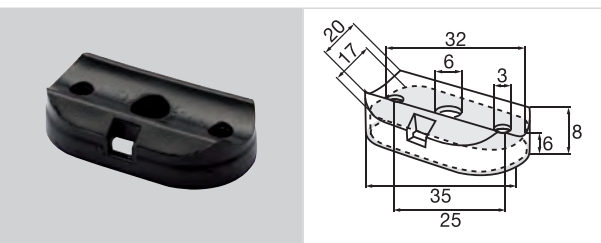

	Ø mm					pcs.	Code	EAN-Code 4001073 ...
	20	20				100	15 9470 01	...299793
	25	20				100	15 9471 01	...299861
	20	25				100	15 9480 01	...299977
	25	25				100	15 9481 01	...299984
	30	40				100	15 9472 01	...299878
	30	50				100	15 9482 01	...299991
	20	20				100	15 9473 01	...299885
	25	20				100	15 9474 01	...299892
	20	25				100	15 9483 01	...300062
	25	25				100	15 9484 01	...300079
	30	40				100	15 9475 01	...299960
	30	50				100	15 9485 01	...300086

Basis oval/rund zum Anschrauben an z.B. Rundrohre





Oval/round base for screwing on e.g. round tubes

Base ovale/ronde à visser par ex. aux tubes ronds

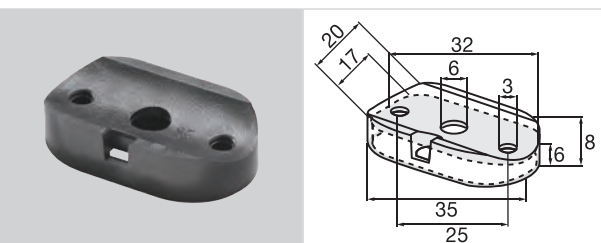





	Ø mm					pcs.	Code	EAN-Code 4001073 ...
	35x20	12				100	15 9412 01	...308686
	35x20	14				100	15 9415 01	...300574
	35x20	12				100	15 9413 01	...308761
	35x20	14				100	15 9416 01	...307474
	35x20	12				100	15 8950 01	...219937

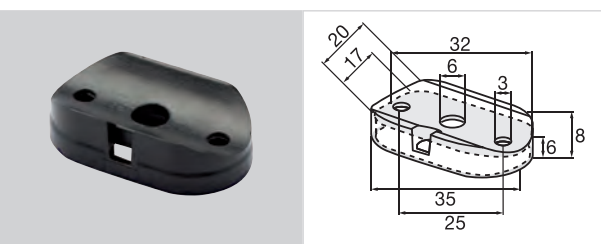





	Ø mm					pcs.	Code	EAN-Code 4001073 ...
	35x20	20				100	15 9425 01	...300567
	35x20	20				100	15 9424 01	...307481
	35x20	20				100	15 9414 01	...420104

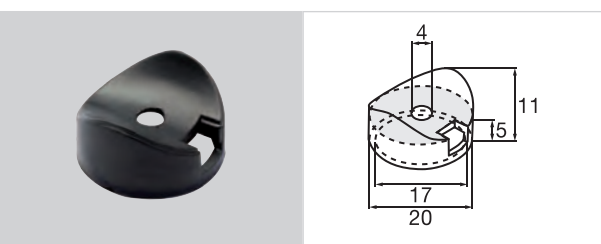

	Ø mm					pcs.	Code	EAN-Code 4001073 ...
	35x20	25				100	15 9445 01	...300499
	35x20	25				100	15 9444 01	...307498
	35x20	25				100	15 9447 01	...311969



	Ø mm					pcs.	Code	EAN-Code 4001073 ...
	20	20				100	15 9436 01	...306293
	20	20				100	15 9438 01	...305999

Basis „KIPPSTOPP“ zum Anschrauben an z.B. Rundrohre  
 Base „KIPPSTOPP“ for screwing on e.g. round tubes  
 Base „KIPPSTOPP“ à visser par ex. aux tubes ronds

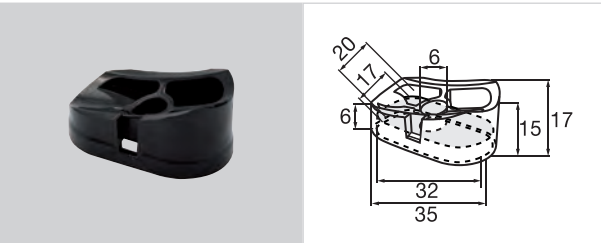

	Ø mm					pcs.	Code	EAN-Code 4001073 ...
	35x20	20				100	15 9427 01	...301670

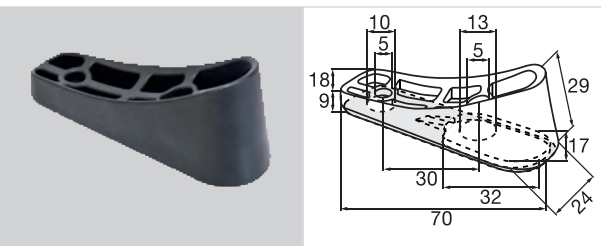

	Ø mm					pcs.	Code	EAN-Code 4001073 ...
	35x20	25				100	15 9433 01	...314472

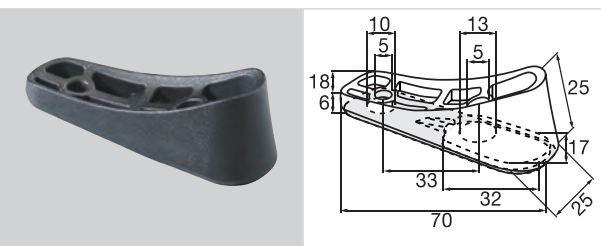

	Ø mm					pcs.	Code	EAN-Code 4001073 ...
	35x20	25				100	15 9431 01	...312874



Basis „KIPPSTOPP“ zum Anschrauben an z.B. Rundrohre  
 Base „KIPPSTOPP“ for screwing on e.g. round tubes  
 Base „KIPPSTOPP“ à visser par ex. aux tubes ronds

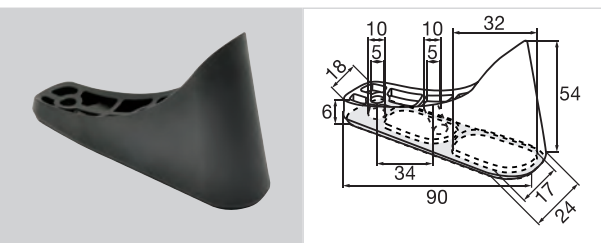

	Ø mm					pcs.	Code	EAN-Code 4001073 ...
	35x20	25				100	16 9430 01	...328776

Kundenspezifischer Artikel hergestellt für  
 This article is produced exclusively for  
 Article spécifique fabriqué pour

**VANERUM**  
 an i3-Solutions company

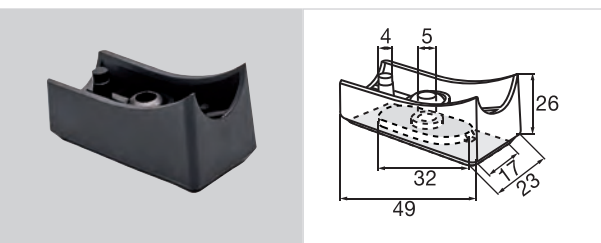

	Ø mm					pcs.	Code	EAN-Code 4001073 ...
	35x20					100	15 9437 01	...319163

Kundenspezifischer Artikel hergestellt für  
 This article is produced exclusively for  
 Article spécifique fabriqué pour

**VANERUM**  
 an i3-Solutions company

Gleitkappe z.B. zum Anschrauben an Rundrohre  
 Glide cap for screwing on e.g. round tubes  
 Capuchon de glissement à visser par. ex. aux tubes ronds

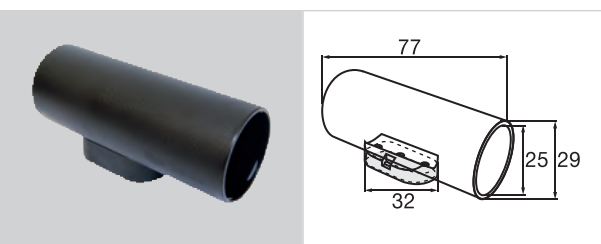

	Ø mm					pcs.	Code	EAN-Code 4001073 ...
	35x20	25				100	15 9432 01	...312881

Kundenspezifischer Artikel hergestellt für  
 This article is produced exclusively for  
 Article spécifique fabriqué pour

**VANERUM**  
 an i3-Solutions company

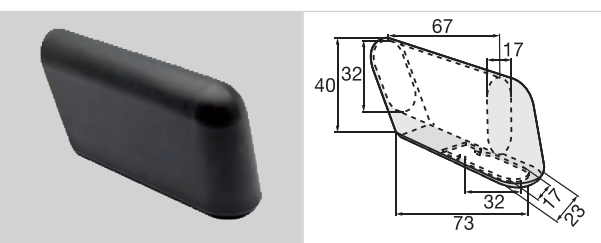





	Ø mm					pcs.	Code	EAN-Code 4001073 ...
	35x20					100	15 9439 01	...320473

Kundenspezifischer Artikel hergestellt für  
 This article is produced exclusively for  
 Article spécifique fabriqué pour

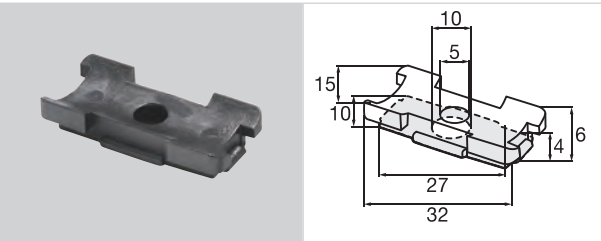
**VANERUM**  
 an i3-Solutions company

Basis „QUATTRO“ zum Anschrauben an z.B. Rundrohre  
 Base „QUATTRO“ for screwing on e.g. round tubes  
 Base „QUATTRO“ à visser par ex. aux tubes ronds



	Ø mm					pcs.	Code	EAN-Code 4001073 ...
	32x15	20-25				100	15 9455 01	...099324
	32x15	20-25				100	15 9457 01	...099348

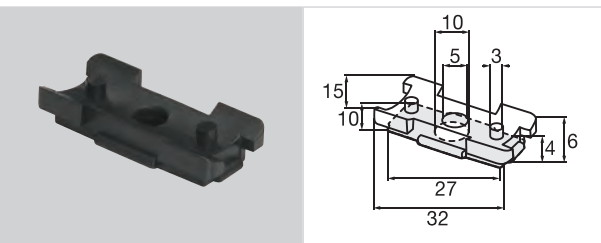

	Ø mm					pcs.	Code	EAN-Code 4001073 ...
	32x15	20-25				100	15 9557 01	...595185

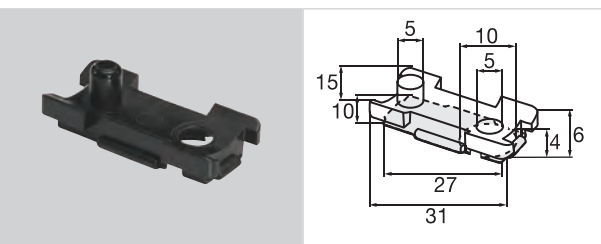

	Ø mm					pcs.	Code	EAN-Code 4001073 ...
	32x15	20-25				100	15 9456 01	...099331

Basis „TANDEM“ zum Befestigen an z.B. Holz-/Stahlrohrmöbel  
 Base „TANDEM“ for fixing on e.g. wooden-/steel tube furniture  
 Base „TANDEM“ à fixer par ex. aux meubles en bois / acier

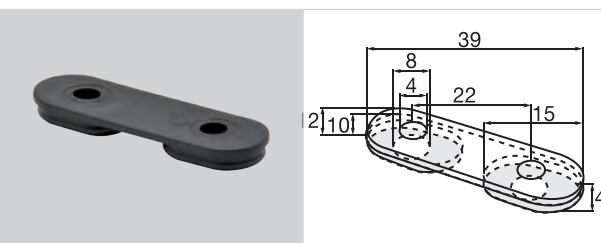

	Ø mm					pcs.	Code	EAN-Code 4001073 ...
	17x12					100	15 9449 01	...309188

Basis „TANDEM“ zum Befestigen an z.B. Holz-/Stahlrohrmöbel  
 Base „TANDEM“ for fixing on e.g. wooden-/steel tube furniture  
 Base „TANDEM“ à fixer par ex. aux meubles en bois / acier

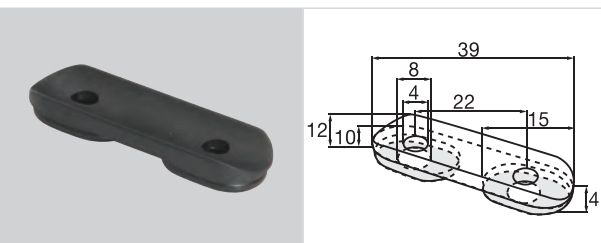

	Ø mm			pcs.	Code	EAN-Code 4001073 ...
	17x12/39x12	12		100	15 9476 01	...314977
	17x12/39x12	14		100	15 9448 01	...309294
	17x12/39x12	12		100	15 9477 01	...315462
	17x12/39x12	14		100	15 9478 01	...318081

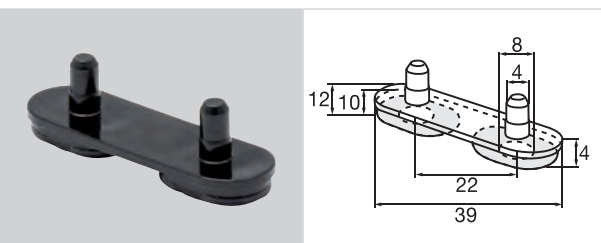

	Ø mm			pcs.	Code	EAN-Code 4001073 ...
	17x12/39x12			100	15 9466 01	...313789
	17x12/39x12			100	16 9402 01	...487428

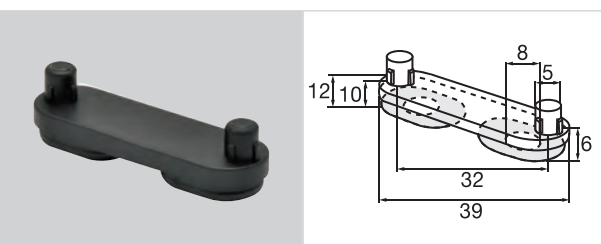

	Ø mm			pcs.	Code	EAN-Code 4001073 ...
	17x12/39x12			100	15 9498 01	...324990

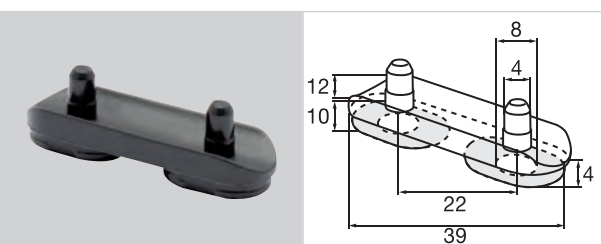

	Ø mm			pcs.	Code	EAN-Code 4001073 ...
	17x12/39x12	12		100	15 9467 01	...312775
	17x12/39x12	14		100	15 9468 01	...313994
	17x12/39x12	12		100	16 9404 01	...091151
	17x12/39x12	14		100	16 9403 01	...139570

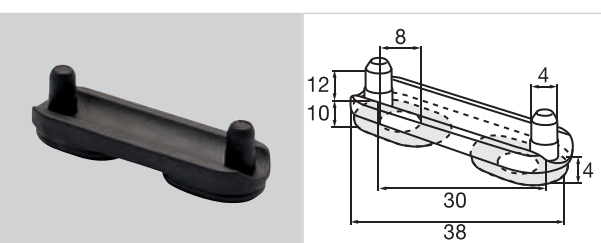

	Ø mm			pcs.	Code	EAN-Code 4001073 ...
	17x12/39x12	10		100	15 9493 01	...324587

Basis „TANDEM UNO“ zum Befestigen an z.B. Holz-/Stahlrohrmöbel  
 Base „TANDEM UNO“ for fixing on e.g. wooden-/steel tube furniture  
 Base „TANDEM UNO“ à fixer par ex. aux meubles en bois / acier

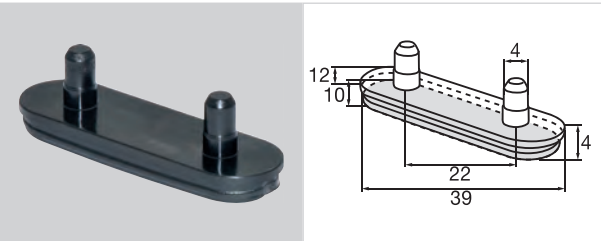

	Ø mm					pcs.	Code	EAN-Code 4001073 ...
	39x12					100	16 9463 01	...331196

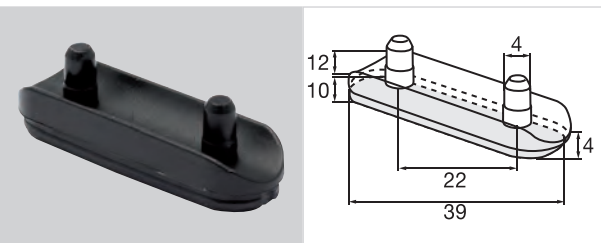

	Ø mm					pcs.	Code	EAN-Code 4001073 ...
	39x12	10				100	16 9464 01	...332094
	39x12	12				100	16 9460 01	...329278
	39x12	14				100	16 9461 01	...329377
	39x12	16				100	16 9467 01	...039962
	39x12	20				100	16 9468 01	...385205
	39x12	25				100	16 9469 01	...385526
	39x12	10				100	16 9470 01	...292633
	39x12	12				100	16 9465 01	...334777
	39x12	14				100	16 9462 01	...330465

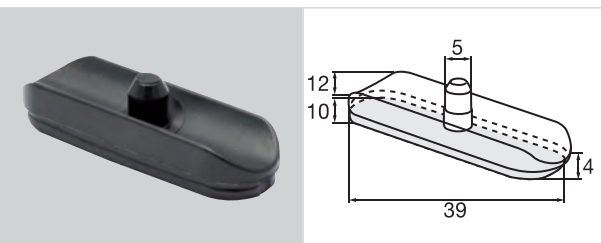

	Ø mm					pcs.	Code	EAN-Code 4001073 ...
	39x12	12				100	16 9459 01	...009484

Basis „QUATTRO“ zum Einpressen in z.B. Rundrohre  
 Base „QUATTRO“ to press into e.g. round tubes  
 Base „QUATTRO“ à enfoncer par ex. dans tubes ronds

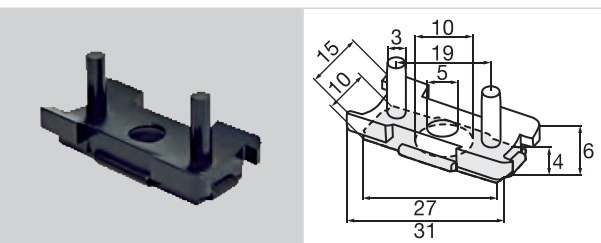

	Ø mm					pcs.	Code	EAN-Code 4001073 ...
	32x15	20-25				100	15 9555 01	...099423

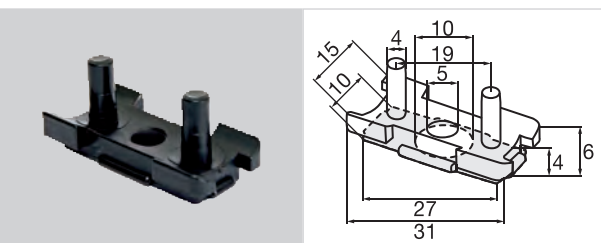

	Ø mm					pcs.	Code	EAN-Code 4001073 ...
	32x15	20-25				100	15 9554 01	...099430

Basis „UNO“ zum Einpressen in Ovalrohre  
 Base „UNO“ to press into oval tubes  
 Base „UNO“ à enfoncer dans tubes ovales

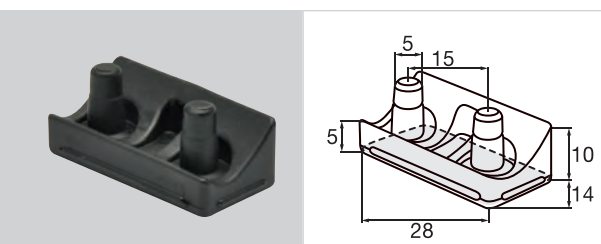

	Ø mm					pcs.	Code	EAN-Code 4001073 ...
	31x17	25				100	15 8071 01	...595789

Basis „UNO“ zum Einpressen in z.B. Rundrohre  
 Base „UNO“ to press into e.g. round tubes  
 Base „UNO“ à enfoncer par ex. dans tubes ronds

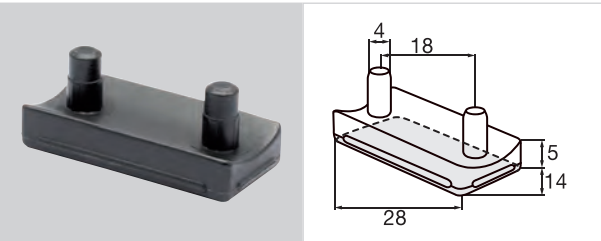

	Ø mm					pcs.	Code	EAN-Code 4001073 ...
	31x17	25				100	15 9558 01	...492736

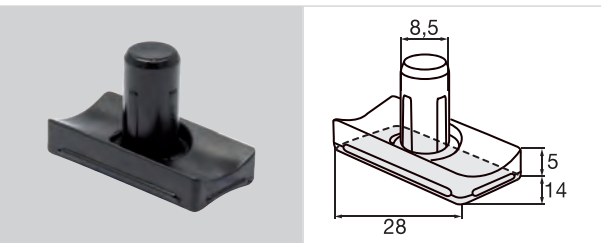

	Ø mm					pcs.	Code	EAN-Code 4001073 ...
	31x17	25				100	15 9578 01	...492743

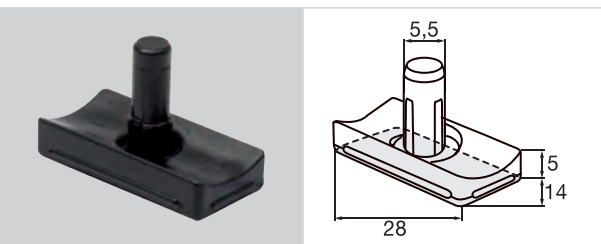

	Ø mm					pcs.	Code	EAN-Code 4001073 ...
	31x17	25				100	15 8180 01	...495003

Basis „QUATTRO“ zum Einpressen in z.B. Stahlrohrmöbel  
 Base „QUATTRO“ to press into e.g. steel tube furniture  
 Base „QUATTRO“ à enfoncer par ex. dans meubles en acier

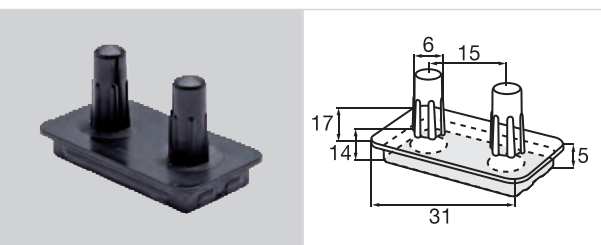

	Ø mm					pcs.	Code	EAN-Code 4001073 ...
	31x17					100	15 9490 01	...321166



Basis oval zum Einpressen in z.B. Stahlrohrmöbel

Oval base to press into e.g. steel tube furniture



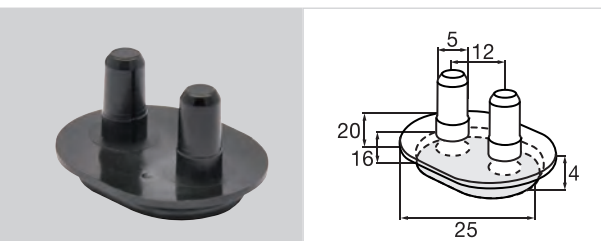



Base ovale à enfoncer par ex. dans meubles en acier

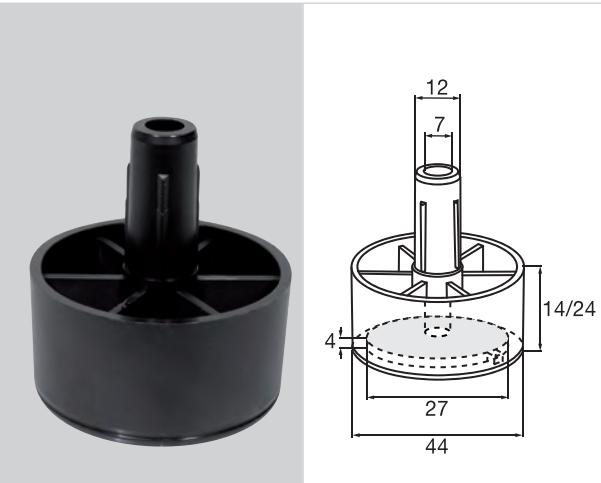

	Ø mm					pcs.	Code	EAN-Code 4001073 ...
	20x25					100	15 9417 01	...053432







Basis „LOUNGE“ zum Einstecken in z.B. Polstermöbel  
 Base „LOUNGE“ for inserting into for e.g. upholstered furniture  
 Base „LOUNGE“ à enficher par ex. dans meubles rembourrés

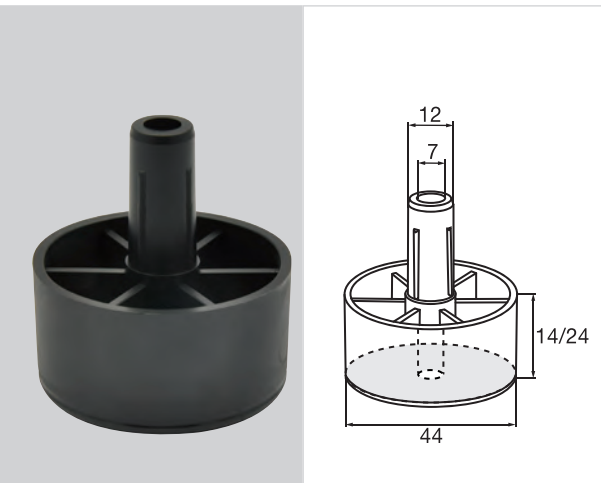

	Ø mm					pcs.	Code	EAN-Code 4001073 ...
	30/40	14				100	16 0400 01**	...053555
	30/40	24				100	16 0401 01**	...053609
	30/40	14				100	16 0410 01**	...053739
	30/40	24				100	16 0411 01**	...053746

Basis „EASY LOUNGE“ zum Einstecken in z.B. Polstermöbel  
 Base „EASY LOUNGE“ for inserting into for e.g. upholstered furniture  
 Base „EASY LOUNGE“ à enficher par ex. dans meubles rembourrés











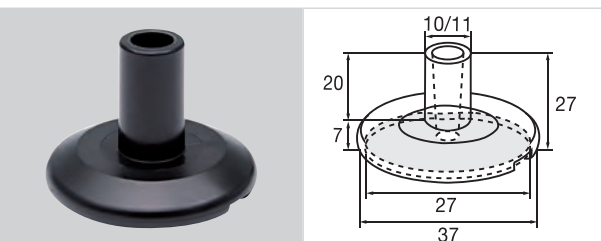

	Ø mm					pcs.	Code	EAN-Code 4001073 ...
	40	14				100	16 0404 01**	...053630
	40	24				100	16 0405 01**	...053647
	40	14				100	16 0414 01**	...053814
	40	24				100	16 0415 01**	...053821

Basis „PIEDI“ zum Einstecken in z.B. Rundrohre / Fußkreuze









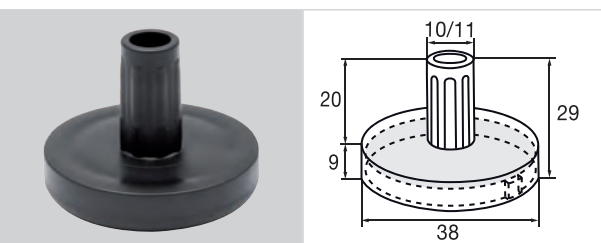

Base „PIEDI“ for putting into e.g. round tubes / cross tubes

Base „PIEDI“ à enficher dans par ex. des tubes ronds / piètements



	Ø mm				pcs.	Code	EAN-Code 4001073 ...
	30	10			100	15 9231 01	...046113
	30	11			100	16 9130 01	...055313
	30	11,5			100	15 9232 01	...047936
	30	11			100	16 9131 01	...333886
	30	11,5			100	16 9132 01	...417456
	30	11,5			100	15 9235 01	... 048346
	30	11,5			100	15 9233 01	...048322
	30	11,5			100	15 9234 01	...048339



	Ø mm				pcs.	Code	EAN-Code 4001073 ...
	30	10			100	15 9101 01**	...216707
	30	11			100	15 9102 01**	...030761
	30	11	Ultrasoft/Hyper		100	16 9135 01**	...415339
	30	11,5			100	15 9103 01**	...414646
	30	10			100	15 9104 01**	...415407
	30	11			100	16 9133 01**	... 287554
	30	11	Ultrasoft/Hyper		100	16 9134 01**	...089693
	30	11,5			100	15 9106 01**	...416541

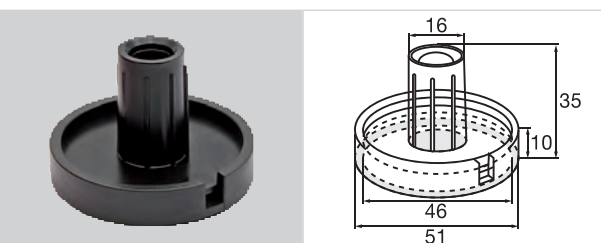









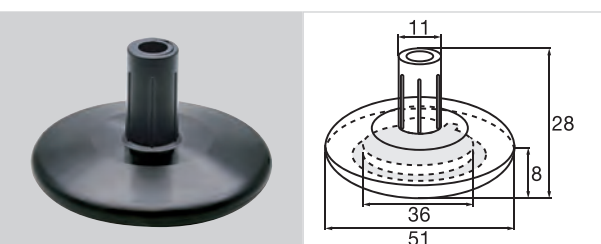



	Ø mm				pcs.	Code	EAN-Code 4001073 ...
	50	16			100	15 9139 01	...025842

Basis „PIEDI“ zum Einstecken für z.B. Kastenmöbel

Base „PIEDI“ for putting in for e.g. case furniture







Base „PIEDI“ à enficher par ex. pour meubles à caisson

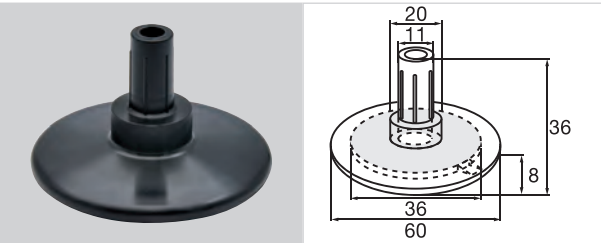







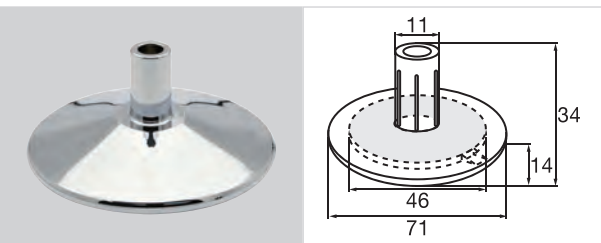

	Ø mm				pcs.	Code	EAN-Code 4001073 ...
	40	10	Ultrasoft/Hyper		100	15 8556 01**	...219951
	40	11	Ultrasoft/Hyper		100	15 8557 01**	...220124
	40	11,5	Ultrasoft/Hyper		100	15 8544 01 **	...331899
	40	11,5	Ultrasoft/Hyper		100	15 8550 01 **	...332193
	40	10	Ultrasoft/Hyper		100	15 8559 01**	...220001
	40	11	Ultrasoft/Hyper		100	15 8560 01**	...417821
	40	11,5	Ultrasoft/Hyper		100	15 8547 01**	...067538
	40	11,5	Ultrasoft/Hyper		100	15 8553 01**	...332285

Basis „PIEDI“ zum Einstecken für z.B. Kastenmöbel  
 Base „PIEDI“ for putting in for e.g. case furniture  
 Base „PIEDI“ à enficher par ex. pour meubles à caisson



	Ø mm			pcs.	Code	EAN-Code 4001073 ...
	40	11,5	Ultrasoft/Hyper	100	15 8545 01**	...331967
	40	11,5	Ultrasoft/Hyper	100	15 8551 01**	...332261
	40	11,5	Ultrasoft/Hyper	100	15 8548 01**	...067545
	40	11,5	Ultrasoft/Hyper	100	15 8554 01**	...332292



	Ø mm			pcs.	Code	EAN-Code 4001073 ...
	50	11	Ultrasoft	100	15 4275 01	...139761
	50	11	Hyper	100	15 4276 01	...290158
	50	11	Ultrasoft	100	15 4245 01	...330892
	50	11	Hyper	100	15 4246 01	...330960

Basis „PIEDI“ mit Stift zum Einstecken für z.B. Drehstühle  
 Base „PIEDI“ with stem for putting in for e.g. swivel chairs  
 Base „PIEDI“ avec cheville à enficher par ex. pour chaises pivotantes

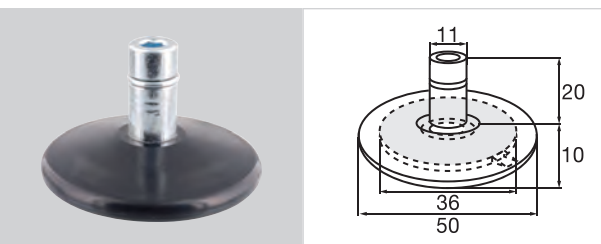



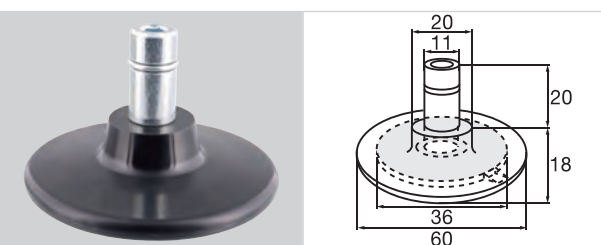



	Ø mm			pcs.	Code	EAN-Code 4001073 ...
	30	11	Ultrasoft/Hyper	100	15 8557 61**	...201246

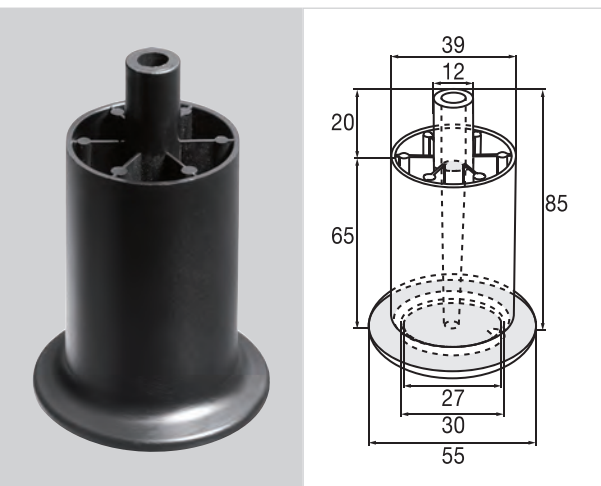

	Ø mm			pcs.	Code	EAN-Code 4001073 ...
	40	11	Ultrasoft/Hyper	100	15 8545 61**	...399141







Basis „PIEDI” zum Einstecken für z.B. Kastenmöbel  
 Base „PIEDI” for putting in for e.g. case furniture  
 Base „PIEDI” à enficher par ex. pour meubles à caisson

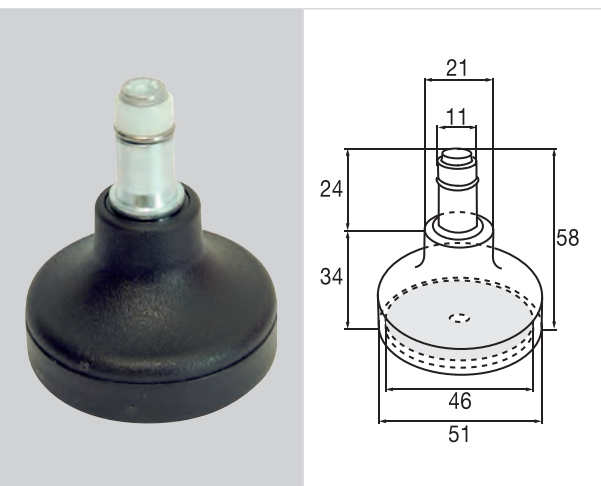

	Ø mm					pcs.	Code	EAN-Code 4001073 ...
	30	12				100	15 9034 01	...037104
	30	12				100	15 9042 01	...298598
	30	12				100	15 9035 01	...048223
	30	12				100	15 9039 01	...048230







Basis „PIEDI” zum Einstecken für z.B. Drehstühle  
 Base „PIEDI” for putting in for e.g. swivel chairs  
 Base „PIEDI” à enficher par ex. pour chaises pivotantes

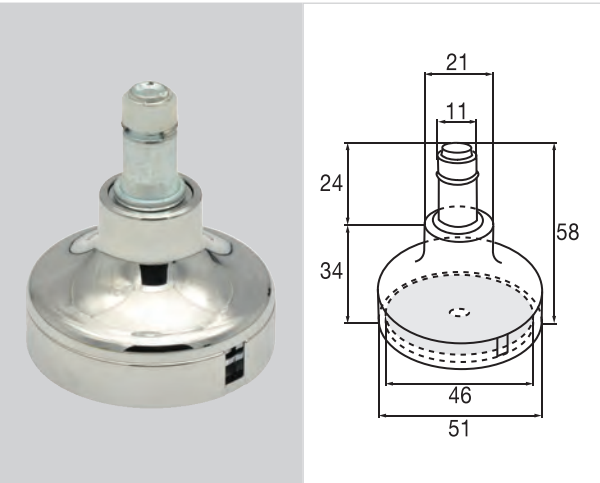

	Ø mm					pcs.	Code	EAN-Code 4001073 ...
	50	11				100	15 9137 01	...050431
	50	11				100	15 9138 01	...050455
	50	11				100	15 9135 01	...052930
	50	11				100	15 9134 01	...052923







Basis „PIEDI” zum Einstecken für z.B. Drehstühle  
 Base „PIEDI” for putting in for e.g. swivel chairs  
 Base „PIEDI” à enficher par ex. pour chaises pivotantes

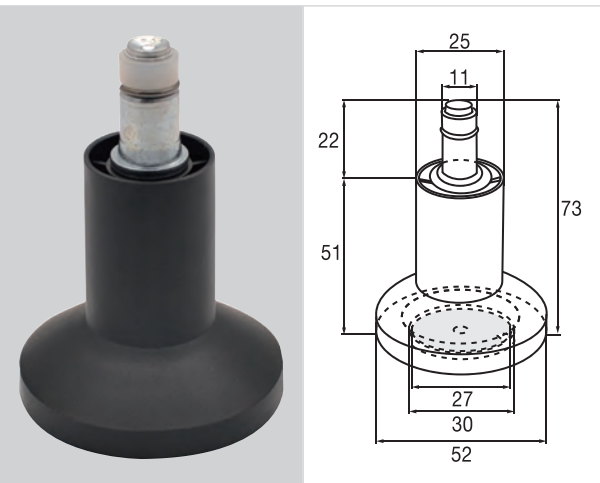

	Ø mm					pcs.	Code	EAN-Code 4001073 ...
	50	11				100	15 9142 01	...053401
	50	11				100	15 9143 01	...053418
	50	11				100	15 9141 01	...053029
	50	11				100	15 9147 01	...053036

Basis „PIEDI” zum Einstecken für z.B. Drehstühle  
 Base „PIEDI” for putting in for e.g. swivel chairs  
 Base „PIEDI” à enficher par ex. pour chaises pivotantes







	Ø mm					pcs.	Code	EAN-Code 4001073 ...
	30	11				100	15 9046 01	...050424
	30	11				100	15 9041 01	...298581
	30	11				100	15 9043 01	...050417
	30	11				100	15 9040 01	...053043

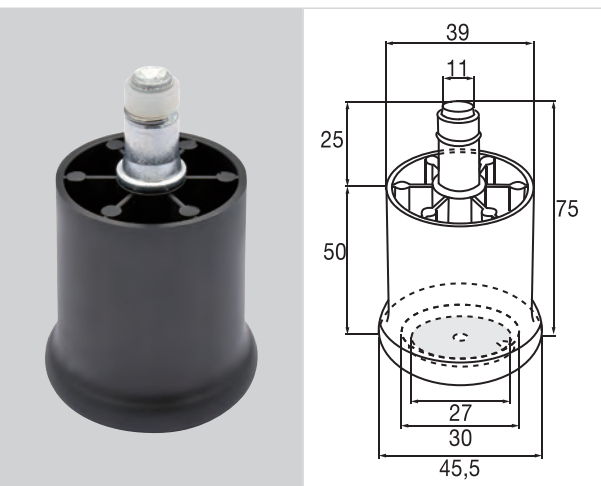





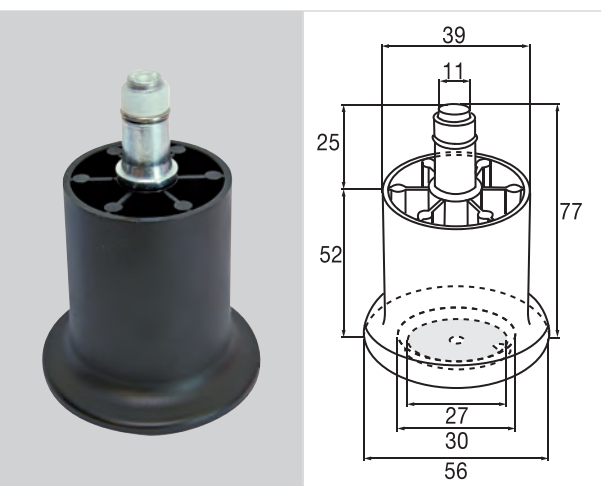

Basis „PIEDI” zum Einstecken für z.B. Drehstühle  
 Base „PIEDI” for putting in for e.g. swivel chairs  
 Base „PIEDI” à enficher par ex. pour chaises pivotantes



	Ø mm			pcs.	Code	EAN-Code 4001073 ...
	30	11		100	16 9038 01	...417432
	30	11	Ultrasoft	100	16 9039 01	...035070



	Ø mm			pcs.	Code	EAN-Code 4001073 ...
	30	11		100	15 9038 01	...048001
	30	11		100	15 9048 01	...048315
	30	11		100	15 9049 01	...048254
	30	11		100	15 9044 01	...048308

Basis „PIEDI“ zum Einstecken für z.B. Drehstühle  
 Base „PIEDI“ for putting in for e.g. swivel chairs  
 Base „PIEDI“ à enficher par ex. pour chaises pivotantes

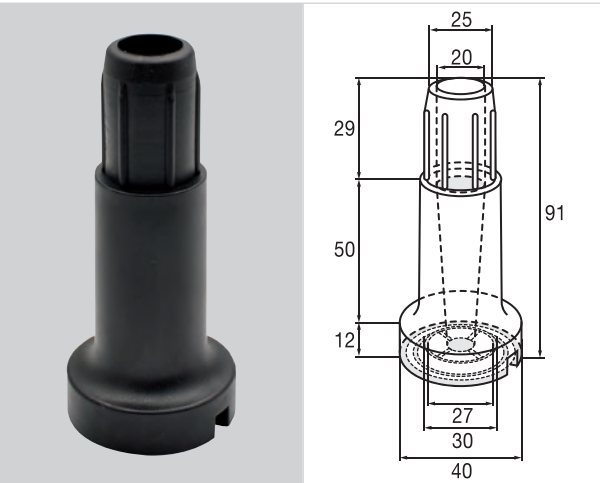



						pcs.	Code	EAN-Code 4001073 ...
30	25					100	15 9058 01**	...052541

Kundenspezifischer Artikel hergestellt für **interstuhl**  
 This article is produced exclusively for  
 Article spécifique fabriqué pour

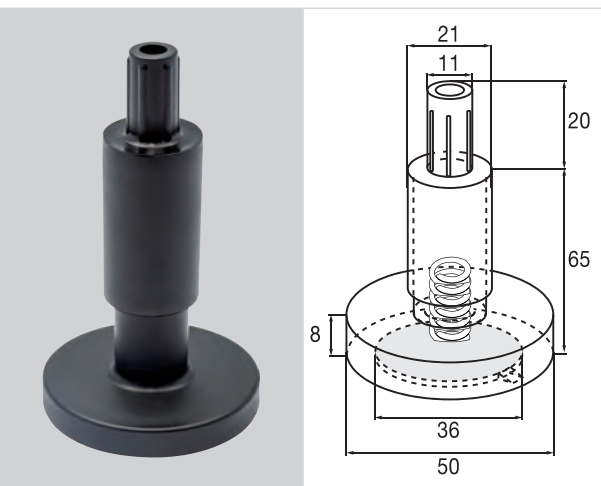
Basis „PIEDI EQUALIZER 2.0” zum Einstecken für z.B. Drehstühle  
 Base „PIEDI EQUALIZER 2.0” for putting in for e.g. swivel chairs  
 Base „PIEDI EQUALIZER 2.0” à enficher par ex. pour chaises pivotantes



	Ø mm			pcs.	Code	EAN-Code 4001073 ...
	40	11,5	Ultrasoft/Hyper	100	15 8572 01**	...220629
	40	11,5	Hyper/Ultrasoft	100	15 8573 01**	...418552
<b>STRONG</b>	40	11,5	Hyper/Ultrasoft	100	15 8574 01**	...087734

Möbelgleiter mit Verstelle schraube zum Einstecken für z.B. Polstermöbel  
 furniture glides with adjusting screw for putting in for e.g. upholstered furniture

patins de meubles avec vis de réglage pour enficher par ex. dans meubles rembourrés

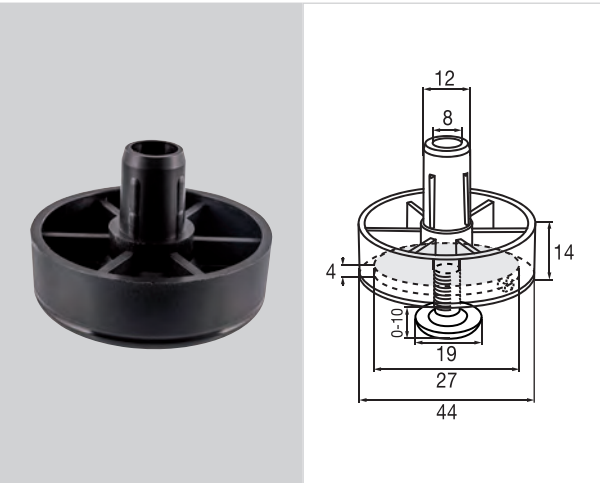

	Ø mm					pcs.	Code	EAN-Code 4001073 ...
	44	11,5/12,5				100	16 0950 01	...331363

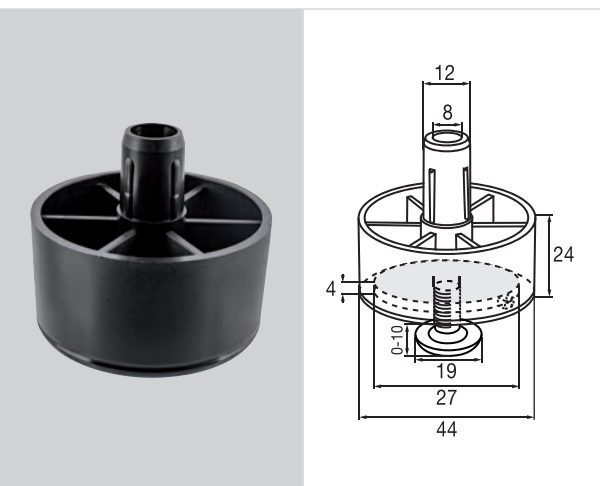







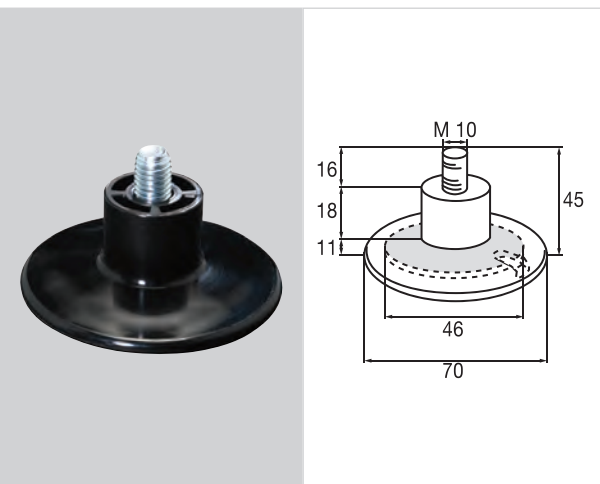

	Ø mm					pcs.	Code	EAN-Code 4001073 ...
	44	11,5/12,5				100	16 0949 01	...331295

Basis „JUSTUS” mit höhenverstellbarem Gewinde

Base „JUSTUS” with height adjustable thread

Base „JUSTUS” avec filetage réglable en hauteur







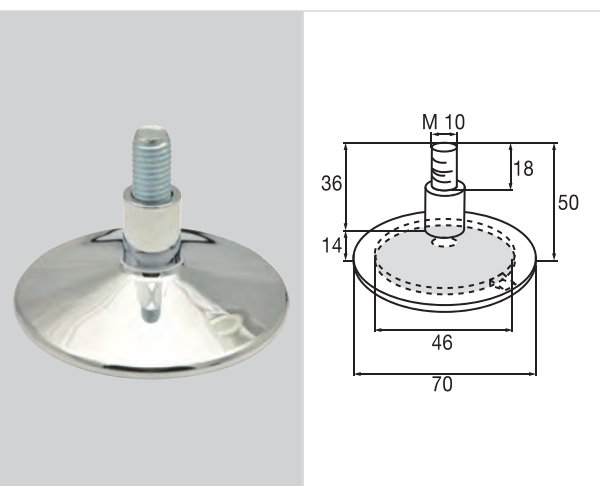

	Ø mm	M x		pcs.	Code	EAN-Code 4001073 ...
	50	10x16	Ultrasoft	100	15 4252 01*	...104585
	50	10x16	Hyper	100	15 4254 01*	...104660
	50	10x16	Super	100	15 4250 01*	...104561
	50	10x16	Ultrasoft	100	15 4257 01*	...104691
	50	10x16	Hyper	100	15 4259 01*	...104776
	50	10x16	Super	100	15 4255 01*	...104677

Kundenspezifischer Artikel hergestellt für  
This article is produced exclusively for  
Article spécifique fabriqué pour

**brunner ::**



	Ø mm	M x		pcs.	Code	EAN-Code 4001073 ...
	50	10x18	Hyper	100	15 4155 01*	...021042
	50	10x18	Ultrasoft	100	15 4154 01*	...021035
	50	10x18	Hyper	100	15 4166 01*	...028638
	50	10x18	Hyper	100	15 4058 01*	...021240

Kundenspezifischer Artikel hergestellt für  
This article is produced exclusively for  
Article spécifique fabriqué pour









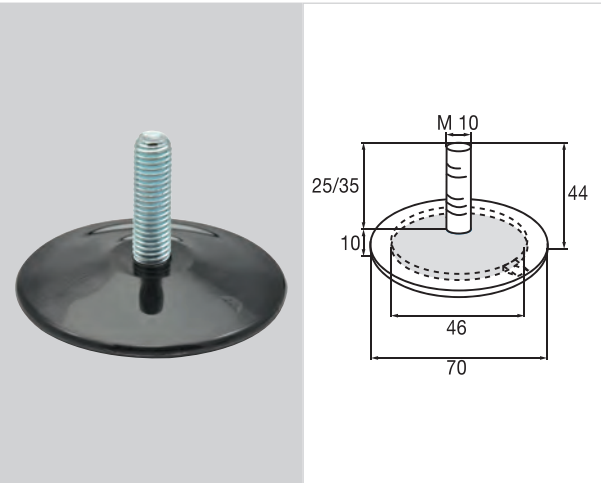



**brunner ::**

Basis „JUSTUS” mit höhenverstellbarem Gewinde

Base „JUSTUS” with height adjustable thread

Base „JUSTUS” avec filetage réglable en hauteur











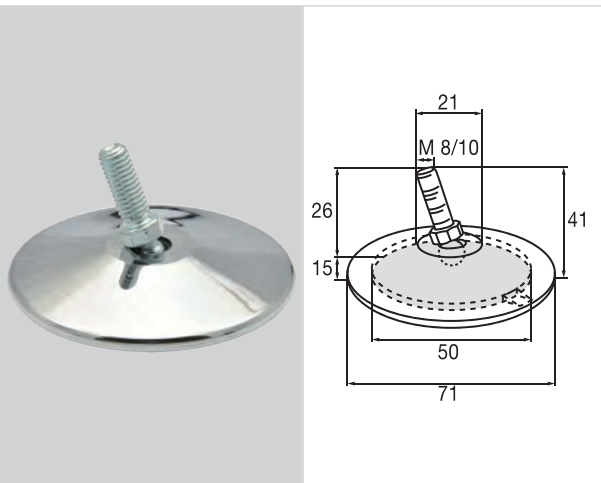

	Ø mm	M x		pcs.	Code	EAN-Code 4001073 ...
	50	10x25	Ultrasoft	100	16 4241 01*	...328974
	50	10x25	Black	100	16 4240 01*	...328967
	50	10x35	Black	100	15 4249 01*	...104493
	50	10x35	Ultrasoft	100	15 4248 01*	...104479
	50	10x25	Black	100	16 4242 01*	...328981
	50	10x25	Ultrasoft	100	16 4243 01*	...328998
	50	10x35	Hyper	100	15 4264 01*	...104363
	50	10x35	Black	100	15 4260 01*	...104486
	50	10x35	Ultrasoft	100	15 4261 01*	...104462
	50	10x35	Ultrasoft	100	15 4265 01*	...104295
	50	10x35	Hyper	100	15 4266 01*	...104288

Basis „JUSTUS” mit höhenverstellbarem Gewinde und Kugelgelenk

Base „JUSTUS” with height adjustable thread and a ball-and-socket joint

Base „JUSTUS” avec filetage réglable en hauteur et articulation sphérique



	Ø mm	M x		pcs.	Code	EAN-Code 4001073 ...
	50	8x25	Black	100	15 4267 01*	...103960
	50	8x25	Ultrasoft	100	15 4268 01*	...103977
	50	10x25	Black	100	15 4269 01*	...103984
	50	10x25	Ultrasoft	100	15 4270 01*	...104066
	50	8x25	Black	100	15 4271 01*	...104073
	50	8x25	Ultrasoft	100	15 4272 01*	...104080
	50	10x25	Black	100	15 4273 01*	...104165
	50	10x25	Ultrasoft	100	15 4274 01*	...104172









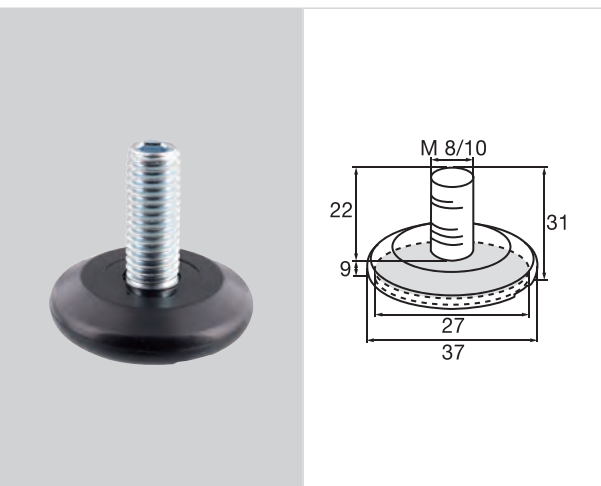



















Basis „JUSTUS” mit höhenverstellbarem Gewinde

Base „JUSTUS” with height adjustable thread

Base „JUSTUS” avec filetage réglable en hauteur



	Ø mm	M x			pcs.	Code	EAN-Code 4001073 ...
	30	8x10	Ultrasoft		100	15 4136 01*	...068238
	30	8x10	Hyper		100	15 4171 01*	...332087
	30	8x10	Black		100	15 4145 01*	...068139
	30	8x20	Ultrasoft		100	15 4150 01*	...068214
	30	8x20	Hyper		100	15 4159 01*	...069808
	30	8x20	Black		100	15 4149 01*	...068207
	30	8x25	Ultrasoft		100	15 4151 01*	...068306
	30	8x25	Hyper		100	15 4129 01*	...069044
	30	8x25	Black		100	15 4140 01*	...067903
	30	10x25	Ultrasoft		100	15 4161 01*	...068948
	30	10x25	Hyper		100	15 4139 01*	...069921
	30	10x25	Black		100	15 4130 01*	...068719
	30	10x25	Syno		100	15 4178 01*	...449792
	30	8x25	Black		100	15 4144 01*	... 068108
	30	10x15	Ultrasoft		100	15 4128 01*	... 219739
	30	10x25	Ultrasoft		100	15 4138 01*	... 069907
	30	10x25	Black		100	15 4134 01*	... 068115
	30	8x25	Black		100	15 4143 01*	... 067934
	30	10x25	Black		100	15 4240 01*	... 111101
	30	8x25	Black		100	15 4141 01*	... 067910
	30	10x25	Black		100	15 4131 01*	... 069310
	30	8x25	Ultrasoft		100	15 4165 01*	... 067736
	30	8x25	Black		100	15 4142 01*	... 067927
	30	10x25	Black		100	15 4132 01*	...072013

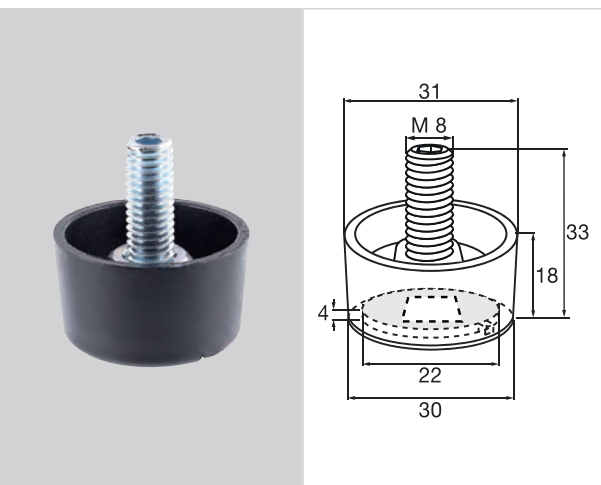

	Ø mm	M x			pcs.	Code	EAN-Code 4001073 ...
	25	8x25			100	15 4179 01*/**	...005363

Basis „JUSTUS” mit höhenverstellbarem Gewinde und Kugelgelenk  
 Base „JUSTUS” with height adjustable thread and a ball-and-socket joint  
 Base „JUSTUS” avec filetage réglable en hauteur et articulation sphérique

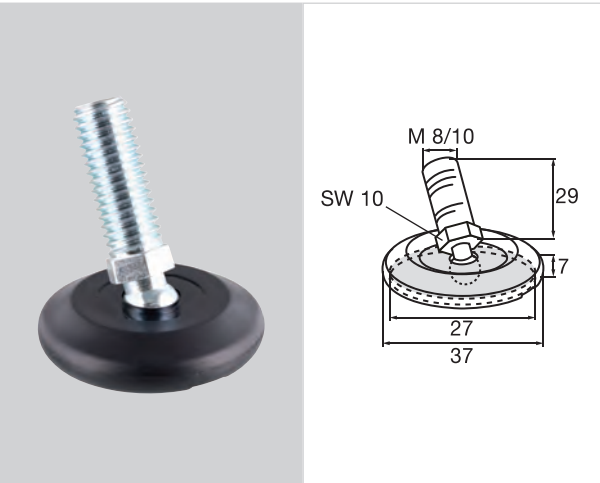

	Ø mm	M x		pcs.	Code	EAN-Code 4001073 ...
	30	8x25	Black	100	15 4352 01*	...068511
	30	10x25	Black	100	15 4342 01*	...069112
	30	8x25	Ultrasoft	100	15 4367 01*	...323863
	30	10x25	Ultrasoft	100	15 4353 01*	...324167
	30	8x25	Black	100	15 4351 01*	...068542
	30	10x25	Black	100	15 4341 01*	...069013
	30	8x25	Ultrasoft	100	16 4143 01*	...081466
	30	10x25	Ultrasoft	100	16 4144 01*	...081961
	30	8x25	Black	100	15 4358 01*	...068740
	30	10x25	Black	100	15 4338 01*	...068801
	30	8x25	Black	100	15 4349 01*	...068528
	30	10x25	Black	100	15 4339 01*	...048032
	30	8x25	Black	100	15 4350 01*	...068535
	30	10x25	Black	100	15 4340 01*	...048124



Basis „JUSTUS SLIM” mit höhenverstellbarem Gewinde  
 Base „JUSTUS SLIM” with height adjustable thread  
 Base „JUSTUS SLIM” avec filetage réglable en hauteur

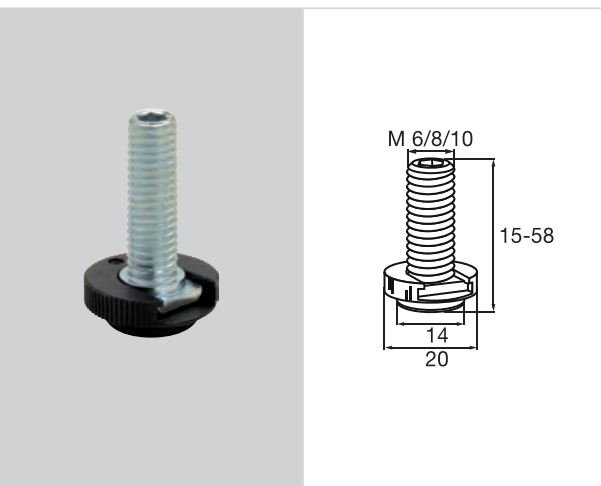

	Ø mm	M x				pcs.	Code	EAN-Code 4001073 ...
	20	6x8				100	15 4180 01	...315028
	20	6x15				100	15 4181 01	...117943
	20	6x25				100	15 4182 01	...514124
	20	8x10				100	15 4187 01	...103755
	20	8x20				100	15 4188 01	...302042
	20	8x25				100	15 4183 01	... 119756
	20	8x40				100	15 4185 01	...455076
	20	8x50				100	15 4186 01	...104233
	20	10x15				100	15 4189 01	...400229
	20	10x25				100	15 4184 01	...317435

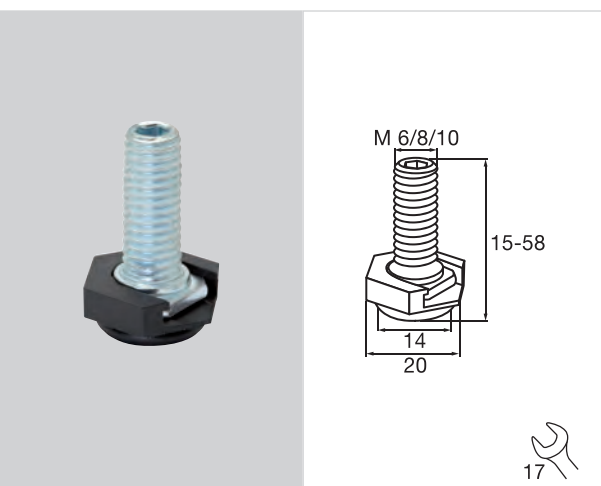







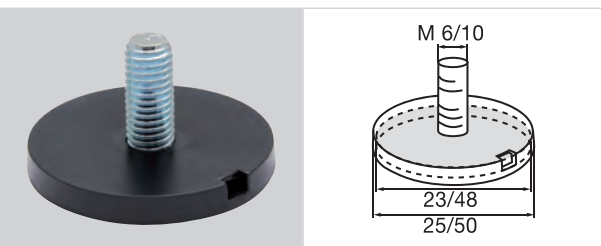

	Ø mm	M x				pcs.	Code	EAN-Code 4001073 ...
	20	6x8				100	15 4280 01	...004090
	20	6x15				100	15 4281 01	...397246
	20	6x25				100	15 4282 01	...199857
	20	8x10				100	15 4287 01	...004793
	20	8x20				100	15 4288 01	...398212
	20	8x25				100	15 4283 01	... 398021
	20	8x40				100	15 4285 01	...199505
	20	8x50				100	15 4286 01	...397307
	20	10x25				100	15 4284 01	...396751











Basis „JUSTUS” mit höhenverstellbarem Gewinde

Base „JUSTUS” with height adjustable thread

Base „JUSTUS” avec filetage réglable en hauteur









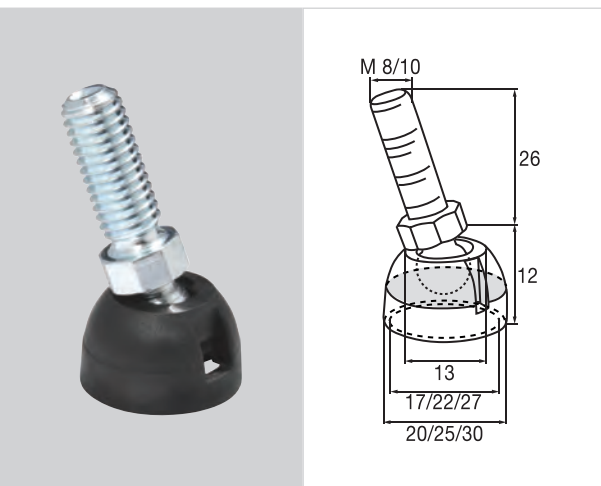







	Ø mm	M x		pcs.	Code	EAN-Code 4001073 ...
	17	6x15		100	15 4195 01	...421538
	17	6x25		100	15 4198 01	...418705
	20	6x15	Hyper	100	15 4169 01	...070002
	20	6x15	Ultrasoft	100	15 4168 01	...069945
	20	6x15	Black	100	15 4199 01	...298505
	20	6x15	Ultrasoft	100	15 4197 01	...198652









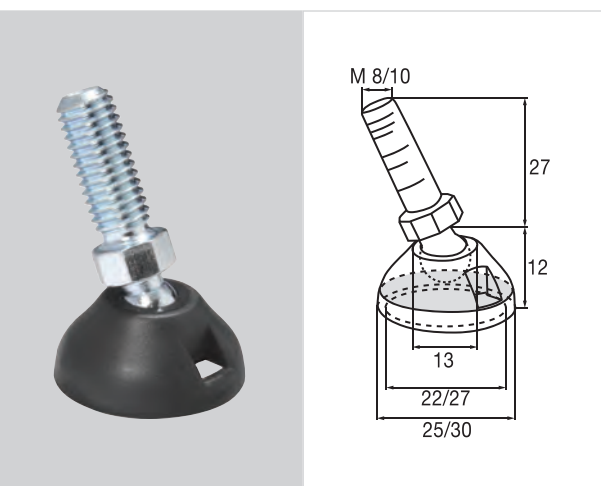



	Ø mm	M x		pcs.	Code	EAN-Code 4001073 ...
	25	6x13	Ultrasoft	100	15 4332 01	...069303
	25	6x13	Hyper	100	15 4333 01	...069242
	25	6x13	Stopp	100	15 4331 01	...069402
	25	6x30	Ultrasoft	100	16 4331 01	...091168
	25	6x30	Stopp	100	15 4323 01	...267754
	25	6x13	Black	100	15 4330 01	...069433
	50	10x25	Hyper	100	15 4263 01	...105773
	50	10x25	Ultrasoft	100	15 4262 01	...105766
	50	10x25	Black	100	15 4277 01	...155877

Basis „JUSTUS” mit höhenverstellbarem Gewinde und Kugelgelenk  
 Base „JUSTUS” with height adjustable thread and a ball-and-socket joint  
 Base „JUSTUS” avec filetage réglable en hauteur et articulation sphérique



	Ø mm	M x		pcs.	Code	EAN-Code 4001073 ...
	20	8x25	Ultrasoft	100	15 4467 01	...325874
	20	8x25	Black	100	15 4360 01	...303384
	20	8x25	Ultrasoft	100	15 4427 01	...326369
	25	10x25	Black	100	15 4366 01	...303391
	25	10x25	Ultrasoft	100	15 4428 01	... 326871
	25	8x25	Black	100	15 4362 01	...303469
	25	10x25	Black	100	15 4368 01	...304985
	30	8x25	Ultrasoft	100	15 4365 01	...323283
	30	8x25	Black	100	15 4364 01	...303483
	30	10x25	Black	100	15 4370 01	...305173
	20	8x25	Black	100	15 4361 01	...303568
	25	8x25	Black	100	15 4363 01	...303582







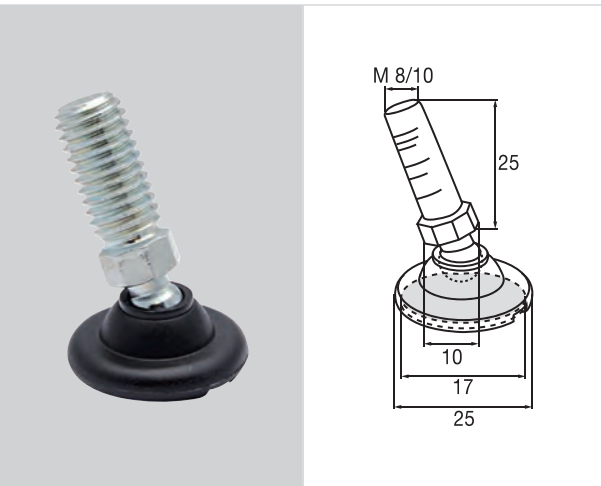

	Ø mm	M x		pcs.	Code	EAN-Code 4001073 ...
	25	8x25	Black	100	15 4382 01**	...300963
	25	10x25	Black	100	15 4388 01**	...300970
	25	8x25	Ultrasoft	100	15 4438 01	...334487
	25	10x25	Ultrasoft	100	15 4429 01	...326895
	30	8x25	Black	100	15 4384 01	... 300987
	30	10x25	Black	100	15 4390 01	...300994
	25	8x25	Black	100	15 4383 01	...301069
	25	8x25	Ultrasoft	100	15 4468 01	...325973
	25	8x25	Hyper	100	15 4466 01	...325867
	25	10x25	Black	100	15 4389 01	...301076

Basis „JUSTUS” Ringdesign flach, mit höhenverstellbarem Gewinde und Kugelgelenk





Base „JUSTUS” ring design flat with height adjustable thread and a ball and socket joint

Base „JUSTUS” design bague plate avec filetage réglable en hauteur et articulation sphérique

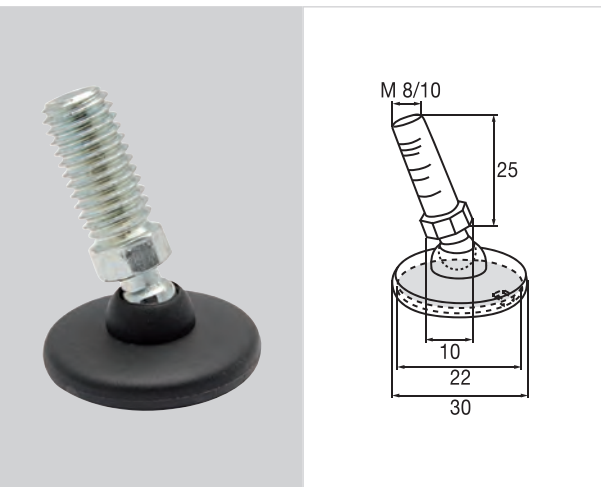

	Ø mm	M x		pcs.	Code	EAN-Code 4001073 ...
	20	8x25	Hyper	100	15 4334 01*	...069204
	20	8x25	Hyper	100	15 4325 01*/**	...070026
	20	10x25	Hyper	100	15 4336 01*/**	...069143











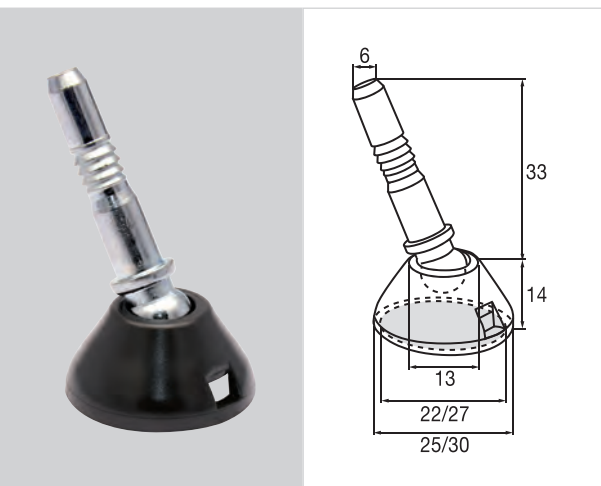

	Ø mm	M x		pcs.	Code	EAN-Code 4001073 ...
	25	8x25	Hyper	100	15 4335 01*	...069235
	25	10x25	Hyper	100	15 4337 01*	...069136

Konische Basis mit Stift und Kugelgelenk

Conical base with stem and a ball-and-socket joint

Base cônica avec cheville et articulation sphérique











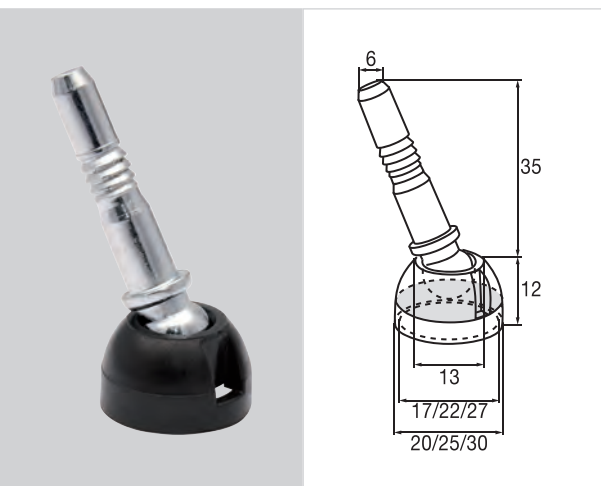

	Ø mm				pcs.	Code	EAN-Code 4001073 ...
	25	Hyper			100	15 4410 01**	...319484
	30	Hyper			100	15 4411 01*	...310979
	25	Hyper			100	15 4412 01*	...319491
	30	Hyper			100	15 4413 01*	...319569
	25	Hyper			100	15 4417 01*	...321982
	25	Ultrasoft			100	15 4418 01	...322293
	25	Hyper			100	15 4415 01**	...319583
	30	Hyper			100	15 4414 01	...319576

Runde Basis mit Stift und Kugelgelenk

Round base with stem and a ball-and-socket joint

Base ronde avec cheville et articulation sphérique



	Ø mm				pcs.	Code	EAN-Code 4001073 ...
	20	Ultrasoft			100	15 4380 01*	...313376
	20	Hyper			100	15 4403 01*	...319361
	25	Hyper			100	15 4404 01*	...319378
	30	Hyper			100	15 4406 01*	...319385
	20	Hyper			100	15 4407 01*	...319392
	25	Hyper			100	15 4408 01*	...319460
	30	Hyper			100	15 4409 01*	...319477
	20	Ultrasoft			100	15 4376 01*	...313062

Konische Basis für Kugelstift Ø 11 mm

Conical base for stem and a ball-and-socket joint Ø 11 mm

Base cônica pour tige sphérique Ø 11 mm

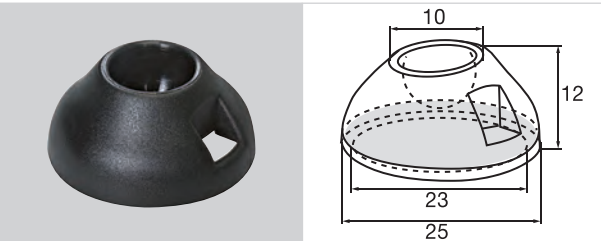





	Ø mm					pcs.	Code	EAN-Code 4001073 ...
	25	Super				100	15 4355 01	...304992

Konische Basis für Kugelstift Ø 10 mm

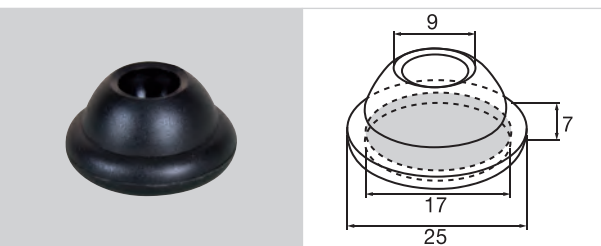
Conical base for stem and a ball-and-socket joint Ø 10 mm

Base cônica pour tige sphérique Ø 10 mm



	Ø mm					pcs.	Code	EAN-Code 4001073 ...
	20					100	16 4055 01	...290257
	20					100	16 4056 01	...138771

Basis „SMART“ zum Einstecken in Fußkreuze/Rundrohre

Base „SMART“ for insertion into star bases/round tubes

Base „SMART“ à enficher dans des piètements/tubes ronds

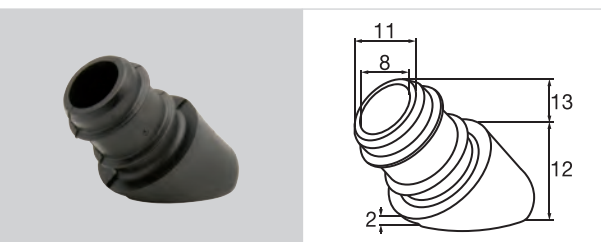

	Ø mm					pcs.	Code	EAN-Code 4001073 ...
	15	16/12	42°			100	16 0523 01	...034899





Basis „SMART“ zum Einstecken in Fußkreuze/Rundrohre

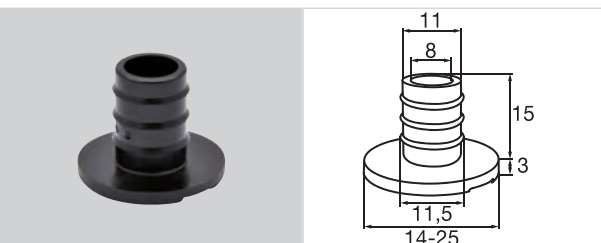

Base „SMART“ for insertion into star bases/round tubes

Base „SMART“ à enficher dans des piètements/tubes ronds



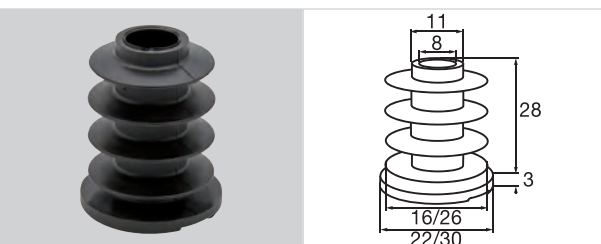



	Ø mm					pcs.	Code	EAN-Code 4001073 ...
■	15	14/11,5	0°			100	16 0524 01	...417449
■	15	16/11,5	0°			100	16 0525 01	...417845
■	15	16/12	0°			100	16 0507 01	...449884
■	15	18/11,5	0°			100	16 0526 01	...035063
■	15	18/15	0°			100	16 0503 01	...220452
■	20	20/11,5	0°			100	16 0529 01	...061642
■	20	22/11,5	0°			100	16 0527 01	...220032
■	20	25/11,5	0°			100	16 0528 01	...418101
■	15	14/11,5	6°			100	16 0537 01	...222135
■	15	14/11,5	12°			100	16 0544 01	...421149
■	15	14/11,5	18°			100	16 0552 01	...418132
■	15	16/11,5	18°			100	16 0553 01	...411904
■	20	20/11,5	0°			100	16 0534 01	...217650

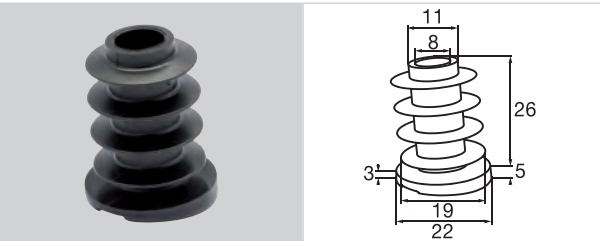

	Ø mm					pcs.	Code	EAN-Code 4001073 ...
■	15	16/10	0°			100	16 0499 01	...334784
■	15	16/12	0°			100	16 0510 01	...334791
■	15	18/14	0°			100	16 0431 01	...054743
■	15	18/15	0°			100	16 0418 01	...053906
■	20	20/16	0°			100	16 0435 01	...054835
■	20	20/17	0°			100	16 0509 01	...378481
■	20	22/10	0°			100	16 0530 01	...418439
■	20	22/16	0°			100	16 0498 01	...333978
■	20	22/18	0°			100	16 0439 01	...055108
■	20	22/19	0°			100	16 0426 01	...054514
■	20	25/16	0°			100	16 0535 01	...256345
■	20	25/21	0°			100	16 0511 01	...334869
■	20	25/22	0°			100	16 0512 01	...334876
■	20	28/25	0°			100	16 0508 01	...314137
■	20	30/26	0°			100	16 0536 01	...257106
■	15	16/10	0°			100	16 0513 01	...334883
■	15	16/12	0°			100	16 0514 01	...334890
■	15	18/14	0°			100	16 0515 01	...334968
■	15	18/15	0°			100	16 0516 01	...334975
■	20	20/16	0°			100	16 0517 01	...334982
■	20	20/17	0°			100	16 0518 01	...334999
■	20	22/18	0°			100	16 0519 01	...335064
■	20	22/19	0°			100	16 0520 01	...335071
■	20	25/21	0°			100	16 0521 01	...335088
■	20	25/22	0°			100	16 0522 01	...335095



Basis „SMART“ zum Einstecken in Fußkreuze/Rundrohre  
 Base „SMART“ for insertion into star bases/round tubes  
 Base „SMART“ à enficher dans des piètements/tubes ronds

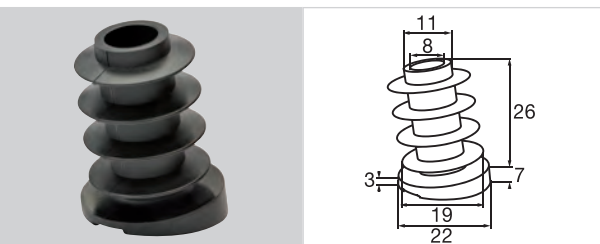

	Ø mm		 Degree°			pcs.	Code	EAN-Code 4001073 ...
■	15	16/10	6°			100	16 0475 01	...494617
■	15	16/12	6°			100	16 0472 01	...494549
■	15	18/14	6°			100	16 0432 01	...054804
■	15	18/15	6°			100	16 0419 01	...053913
■	20	20/16	6°			100	16 0436 01	...054934
■	20	20/17	6°			100	16 0423 01	...054408
■	20	22/18	6°			100	16 0440 01	...055115
■	20	22/19	6°			100	16 0427 01	...054521
■	20	25/21	6°			100	16 0481 01	...494716
■	20	25/22	6°			100	16 0478 01	...494648
■	15	16/10	6°			100	16 0487 01	...494815
■	15	16/12	6°			100	16 0484 01	...494747
■	15	18/14	6°			100	16 0453 01	...494235
■	15	18/15	6°			100	16 0452 01	...494228
■	20	20/16	6°			100	16 0459 01	...494334
■	20	20/17	6°			100	16 0458 01	...494327
■	20	22/18	6°			100	16 0465 01	...494433
■	20	22/19	6°			100	16 0464 01	...494426
■	20	25/21	6°			100	16 0493 01	...494914
■	20	25/22	6°			100	16 0490 01	...494846

Basis „SMART“ zum Einstecken in Rundrohre  
 Base „SMART“ for insertion into round tubes  
 Base „SMART“ à enficher dans des tubes ronds



	Ø mm		 Degree°			pcs.	Code	EAN-Code 4001073 ...
■	15	16/10	12°			100	16 0476 01	...494624
■	15	16/12	12°			100	16 0473 01	...494556
■	15	18/14	12°			100	16 0433 01	...054811
■	15	18/15	12°			100	16 0420 01	...054132
■	20	20/16	12°			100	16 0437 01	...054958
■	20	20/17	12°			100	16 0424 01	...054422
■	20	22/18	12°			100	16 0441 01	...055207
■	20	22/19	12°			100	16 0428 01	...054606
■	20	25/21	12°			100	16 0482 01	...494723
■	20	25/22	12°			100	16 0479 01	...494655
■	15	16/10	12°			100	16 0488 01	...494822
■	15	16/12	12°			100	16 0485 01	...494754
■	15	18/14	12°			100	16 0455 01	...494259
■	15	18/15	12°			100	16 0454 01	...494242
■	20	20/16	12°			100	16 0461 01	...494358
■	20	20/17	12°			100	16 0460 01	...494341
■	20	22/18	12°			100	16 0467 01	...494457
■	20	22/19	12°			100	16 0466 01	...494440
■	20	25/21	12°			100	16 0494 01	...494921
■	20	25/22	12°			100	16 0491 01	...494853

Basis „SMART“ zum Einstecken in Rundrohre

Base „SMART“ for insertion into round tubes

Base „SMART“ à enficher dans des tubes ronds

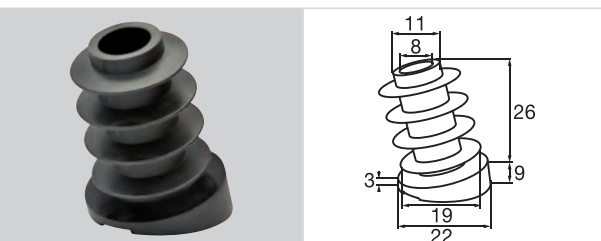





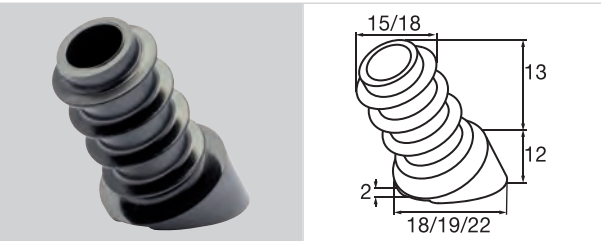

	Ø mm			Degree°		pcs.	Code	EAN-Code 4001073 ...
	15	16/10	18°			100	16 0477 01	...494631
	15	16/12	18°			100	16 0474 01	...494600
	15	18/14	18°			100	16 0434 01	...054828
	15	18/15	18°			100	16 0421 01	...054149
	20	20/16	18°			100	16 0438 01	...055016
	20	20/17	18°			100	16 0425 01	...054507
	20	22/18	18°			100	16 0442 01	...055214
	20	22/19	18°			100	16 0429 01	...054637
	20	25/21	18°			100	16 0483 01	...494730
	20	25/22	18°			100	16 0480 01	...494709
	15	16/10	18°			100	16 0489 01	...494839
	15	16/12	18°			100	16 0486 01	...494808
	15	18/14	18°			100	16 0457 01	...494310
	15	18/15	18°			100	16 0456 01	...494303
	20	20/16	18°			100	16 0463 01	...494419
	20	20/17	18°			100	16 0462 01	...494402
	20	22/18	18°			100	16 0469 01	...494518
	20	22/19	18°			100	16 0468 01	...494501
	20	25/21	18°			100	16 0495 01	...494938
	20	25/22	18°			100	16 0492 01	...494907

Basis „SMART“ zum Einstecken





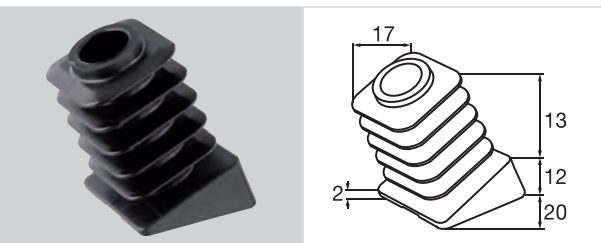

Base „SMART“ for insertion

Base „SMART“ à enficher



	Ø mm		Degree°			pcs.	Code	EAN-Code 4001073 ...
	15	18/14	36°			100	16 0555 01	...400113
	15	18/15	30°			100	16 0556 01	...285703
	15	19/15	36°			100	16 0558 01	...212198
	20	22/18	44°			100	16 0557 01	...087932



	Ø mm		Degree°			pcs.	Code	EAN-Code 4001073 ...
	15	20/17	0°			100	16 0600 01	...202137
	15	20/17	6°			100	16 0601 01	...008395
	15	20/17	12°			100	16 0602 01	...400458
	15	20/17	18°			100	16 0603 01	...008975
	15	20/17	24°			100	16 0604 01	...398816

Basis „SMART BSG“ zum Einpressen in Holzmöbel

Base „SMART BSG“ tp press into wooden furniture

Base „SMART BSG“ pour presser dans meubles en bois

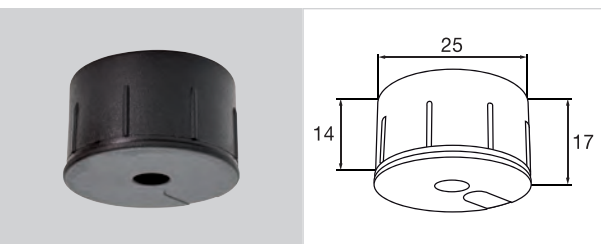



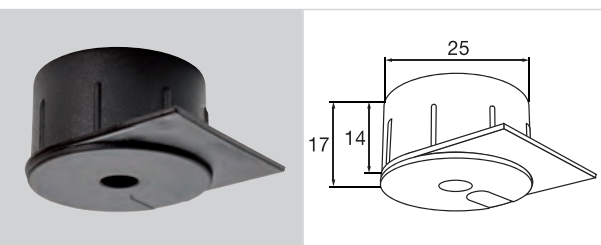



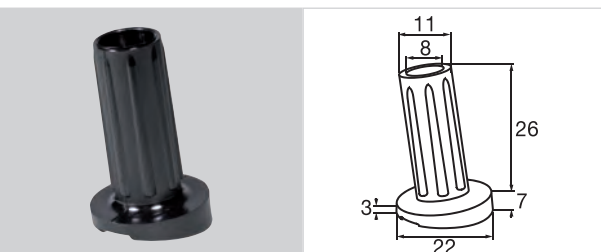

	Ø mm					pcs.	Code	EAN-Code 4001073 ...
	25					100	16 0990 01	...352733



	Ø mm					pcs.	Code	EAN-Code 4001073 ...
	25					100	16 0991 01	...154641

Basis „SILENCER SMART“ zum Einstecken in Rundrohre  
 Base „SILENCER SMART“ for insertion into round tubes  
 Base „SILENCER SMART“ à enficher dans des tubes ronds



	Ø mm			pcs.	Code	EAN-Code 4001073 ...
	15	18/14	0°	100	16 9303 01	...026672
	15	18/14	6°	100	16 9304 01	...412345
	15	18/14	12°	100	16 9305 01	...027679
	15	18/14	18°	100	16 9306 01	...215052

„ABSORBER“ für „SILENCER SMART“ (ohne Zapfen)  
 „ABSORBER“ for „SILENCER SMART“ (without pin)  
 „ABSORBEUR“ pour „SILENCER SMART“ (sans maneton)

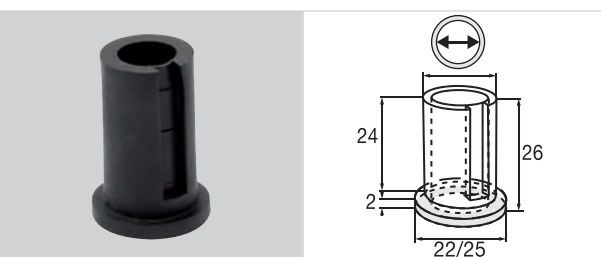





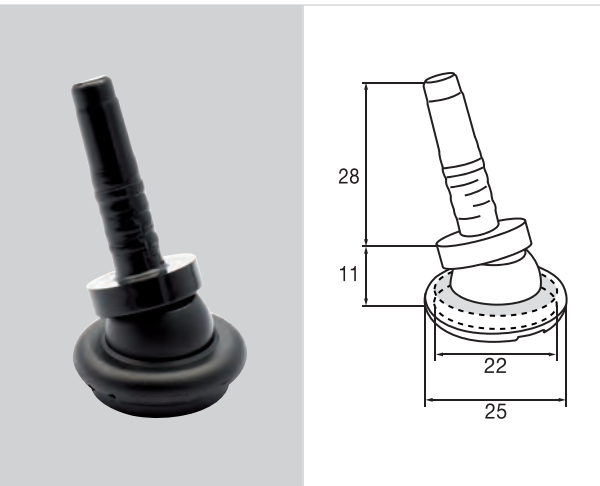

		pcs.	Code	EAN-Code 4001073 ...
	18/14	100	16 9932 01	...092554

Basis „SILENCER SMART“ mit Gelenk und Ringdesign zum Einstecken in passende Absorber

Base „SILENCER SMART“ with articulation and ring design for insertion into suitable absorbers

Base „SILENCER SMART“ avec articulation et design bague à enficher dans des absorbeurs appropriés



	Ø mm				pcs.	Code	EAN-Code 4001073 ...
	20	16	Black		100	16 9391 01*	...030280
	20	18	Black		100	16 9392 01*	...417357
	20	20	Black		100	16 9991 01*	...007763

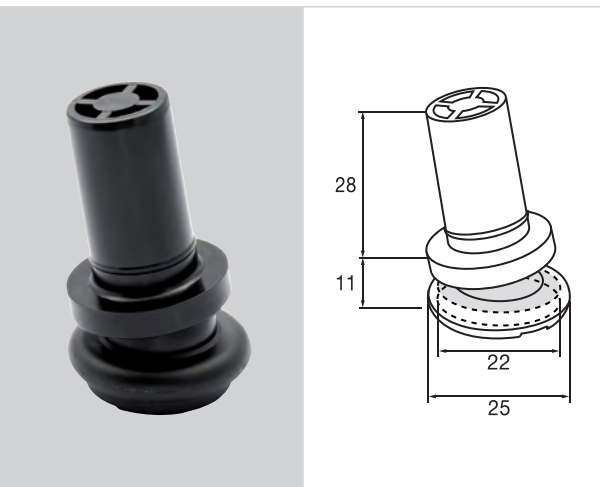







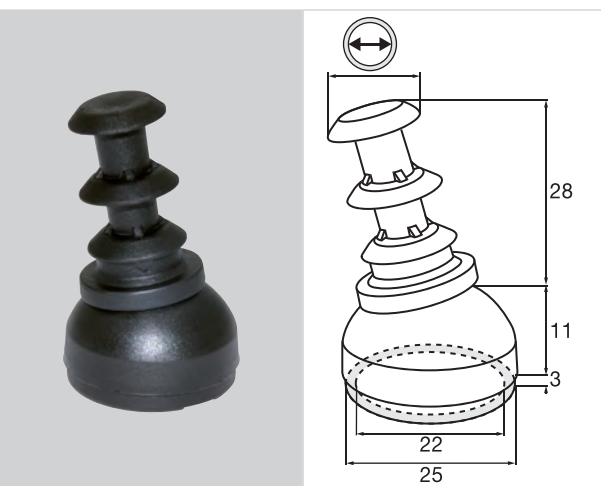

	Ø mm				pcs.	Code	EAN-Code 4001073 ...
	20	22	Black		100	16 9992 01*	...400137

Basis „SMART“ mit Gelenk und rundem Kopf und Bund zum Einstecken in Rundrohre

Base „SMART“ with articulation, round head and collar for insertion into round tubes

Base „SMART“ avec articulation à tête ronde et manchon à enficher dans des tubes ronds



	Ø mm			pcs.	Code	EAN-Code 4001073 ...
	20	16/12	Black	100	16 9829 01*	...286533
	20	16/13	Black	100	16 9828 01*	...222401
	25	18/14	Black	100	16 0948 01*	...330885
	25	22/18	Black	100	16 0945 01*	...330786
	25	25/21	Black	100	16 0946 01*	...330793

Basis „SMART“ mit Gelenk und rundem Kopf zum Einstecken in Rundrohre

Base „SMART“ with articulation, round head for insertion into round tubes

Base „SMART“ avec articulation à tête ronde à enficher dans des tubes ronds

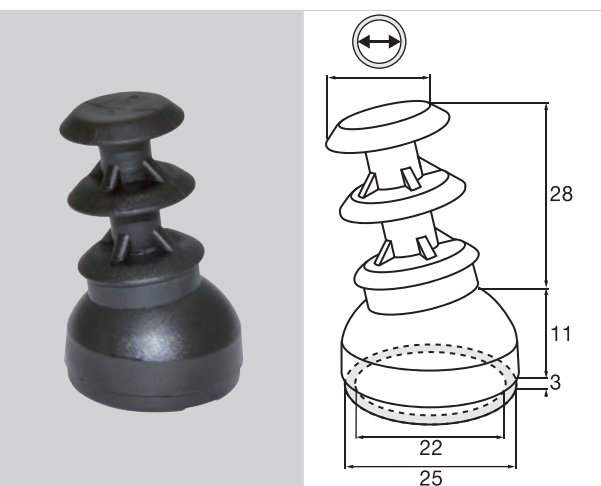







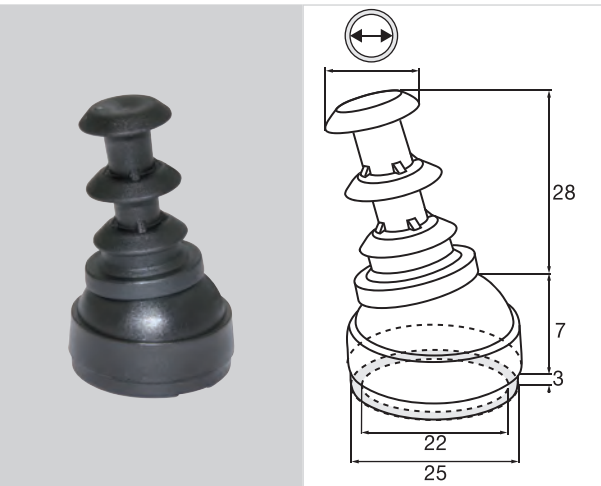

	Ø mm			pcs.	Code	EAN-Code 4001073 ...
	25	22/17	Black	100	16 0947 01	...330878

Basis „SMART“ mit Gelenk und abgesetztem Kopf und Bund zum Einstecken in Rundrohre

Base „SMART“ with articulation and collar for insertion into round tubes

Base „SMART“ avec articulation et manchon à enficher dans des tubes ronds









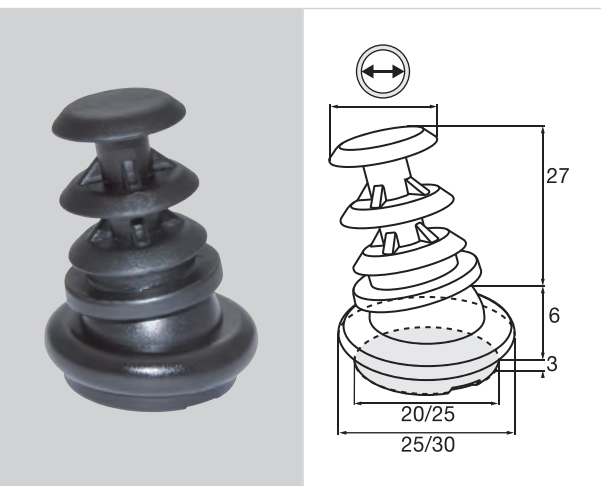

	Ø mm			pcs.	Code	EAN-Code 4001073 ...
	20	18/14	Black	100	16 0956 01*	...332476
	25	18/14	Black	100	16 0951 01*	...331578
	25	20/17	Black	100	16 1949 01*	...331660
	25	22/19	Black	100	16 1945 01*	...331585

Basis „SMART“ mit Gelenk und Bund, Ringdesign zum Einstecken in Rundrohre

Base „SMART“ with articulation and collar, ring design for insertion into round tubes

Base „SMART“ avec articulation et manchon, design bague à enficher dans des tubes ronds





	Ø mm			pcs.	Code	EAN-Code 4001073 ...
	20	16/12	Black	100	16 0958 01*	...220704
	20	18/14	Black	100	16 0957 01*	...222258
	20	22/18	Black	100	16 0955 01*	...465808
	25	22/18	Black	100	16 0943 01*	...330168
	25	25/21	Black	100	16 0944 01	...330175

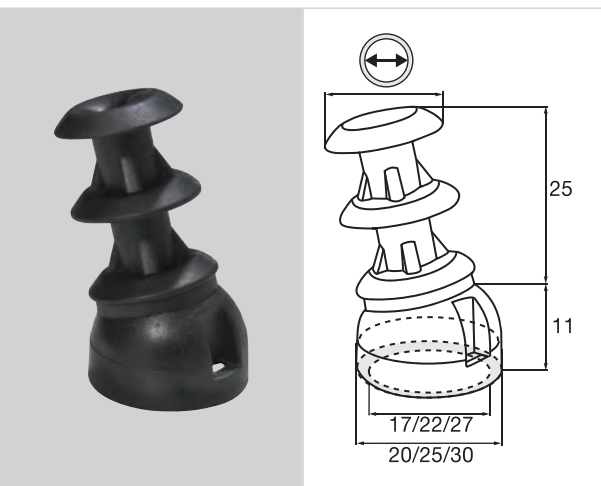

Basis mit Gelenk und rundem Kopf zum Einstecken in Rundrohre  
 Base with articulation and round head for insertion into round tubes  
 Base avec articulation à tête ronde à enficher dans des tubes ronds











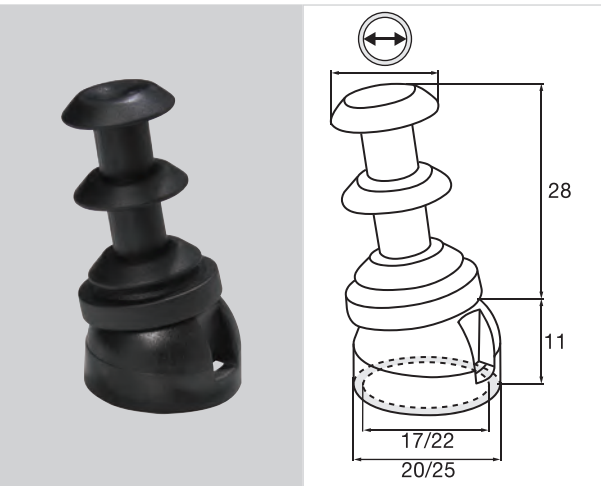



	Ø mm				pcs.	Code	EAN-Code 4001073 ...
	20	14/10	Hyper		100	15 9674 01*/**	...319590
	20	16/10	Hyper		100	15 9677 01*/**	...319668
	20	16/12	Hyper		100	15 9697 01*/**	...319675
	20	16/12	Ultrasoft		100	15 9890 01*/**	...316490
	20	16/13	Hyper		100	15 9698 01*/**	...319682
	25	16/13	Ultrasoft		100	15 9873 01*/**	...197709
	20	18/13	Hyper		100	15 9699 01*/**	...319699
	20	18/14	Hyper		100	15 9640 01*/**	...319767
	25	18/15	Hyper		100	15 9842 01*/**	...312195
	20	20/16	Hyper		100	15 9619 01*/**	...197730
	20	20/16	Ultrasoft		100	15 9899 01*/**	...318883
	20	20/17	Hyper		100	15 9827 01*/**	...306897
	20	20/17	Ultrasoft		100	15 9398 01*/**	...323764
	25	22/17	Hyper		100	15 9805 01*/**	...318173
	25	22/17	Ultrasoft		100	15 9838 01*/**	...313475
	25	22/19	Hyper		100	15 9841 01*/**	...311990
	25	22/19	Ultrasoft		100	16 9367 01*/**	...332179
	25	25/21	Hyper		100	15 9261 01*/**	...197747
	30	30/26	Hyper		100	15 9262 01*	...197754
	30	30/26	Ultrasoft		100	15 9872 01*	...315882
	20	14/10	Hyper		100	15 9206 01*/**	...197808
	20	16/10	Hyper		100	15 9207 01*/**	...319774
	20	16/12	Hyper		100	15 9208 01*/**	...319781
	20	16/13	Hyper		100	15 9209 01*/**	...319798
	20	18/13	Hyper		100	15 9210 01*/**	...319886
	20	18/14	Hyper		100	15 9211 01*/**	...319873
	20	18/15	Hyper		100	15 9212 01*/**	...319880
	20	20/16	Hyper		100	15 9213 01*/**	...319897
	20	20/17	Hyper		100	15 9216 01*/**	...319965
	25	22/17	Hyper		100	15 9217 01*/**	...319972
	25	22/19	Hyper		100	15 9218 01*/**	...319989
	25	22/19	Ultrasoft		100	16 9618 01*/**	...329391
	25	25/21	Hyper		100	15 9219 01*/**	...319996
	30	30/26	Hyper		100	16 0951 01*	...320060

Basis mit Gelenk und rundem Kopf und Bund zum Einstecken in Rundrohre

Base with articulation, round head and collar for insertion into round tubes

Base avec articulation à tête ronde et manchon à enficher dans des tubes ronds







	Ø mm			pcs.	Code	EAN-Code 4001073 ...
	20	14/10	Ultrasoft	100	15 9825 01*/**	...314076
	20	14/10	Hyper	100	15 9263 01*/**	...320077
	20	14/10	Black	100	15 9757 01*/**	...198355
	20	16/10	Hyper	100	15 9264 01*/**	...320084
	20	16/10	Ultrasoft	100	16 9262 01*/**	...331271
	20	16/12	Ultrasoft	100	16 9821 01*/**	...198058
	20	16/12	Hyper	100	15 9829 01*/**	...197624
	20	16/12	Ultrasoft	100	15 9822 01*/**	...197631
	20	18/14	Ultrasoft	100	15 9818 01*/**	...312591
	20	18/14	Hyper	100	15 9266 01*/**	...320169
	30	18/14	Hyper	100	15 9744 01*/**	...310573
	20	18/14	Ultrasoft	100	15 9735 01*/**	...309379
	20	20/16	Ultrasoft	100	15 9237 01*/**	...322699
	20	20/16	Hyper	100	15 9847 01*/**	...315486
	20	20/17	Ultrasoft	100	15 9669 01*/**	...318968
	20	20/17	Hyper	100	15 9201 01*/**	...319088
	25	20/17	Hyper	100	15 9364 01*/**	...322163
	20	20/17	Ultrasoft	100	16 9363 01*/**	...322095
	25	22/18	Ultrasoft	100	15 9832 01*/**	...313390
	25	22/18	Hyper	100	15 9835 01*/**	...313468
	25	25/21	Ultrasoft	100	16 9265 01*/**	...222357
	25	25/21	Hyper	100	15 9253 01*/**	...313291
	30	30/26	Ultrasoft	100	16 9601 01*/**	...061628
	20	14/10	Hyper	100	15 9267 01*/**	...320176
	20	16/10	Hyper	100	15 9268 01*/**	...320183
	20	16/12	Hyper	100	15 9265 01*/**	...320091
	20	18/14	Hyper	100	15 9269 01*/**	...320190
	20	20/16	Hyper	100	15 9270 01*/**	...320268
	20	20/17	Hyper	100	15 9271 01*/**	...320275
	25	22/18	Hyper	100	15 9272 01*/**	...320282
	25	25/21	Hyper	100	15 9273 01*/**	...320299

Basis mit Gelenk und abgesetzem Kopf zum Einstecken in Rundrohre

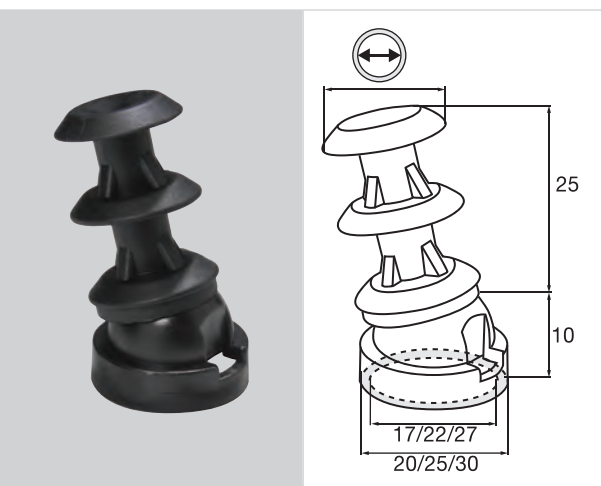
Base with articulation and shouldered head for insertion into round tubes

Base avec articulation à tête décalée à enficher dans des tubes ronds







	Ø mm			pcs.	Code	EAN-Code 4001073 ...
	20	10	Hyper	100	15 9274 01*/**	...320367
	20	10	Hyper	100	15 9276 01*/**	...320374
	20	10	Ultrasoft	100	15 9399 01*/**	...324785
	20	12	Hyper	100	15 9286 01*/**	...320381
	20	12	Ultrasoft	100	15 9693 01*/**	...315561
	20	13	Hyper	100	15 9279 01*/**	...320398
	20	13	Hyper	100	15 9638 01*/**	...314083
	20	13	Ultrasoft	100	15 9257 01*/**	...014815
	20	13	Ultrasoft	100	16 9200 01*/**	...028133
	20	14	Hyper	100	15 9632 01*/**	...315783
	20	15	Hyper	100	15 9615 01*/**	...313277
	20	15	Ultrasoft	100	16 9253 01*/**	...328691
	20	16	Hyper	100	15 9282 01*/**	...320466
	20	17	Hyper	100	15 9287 01*/**	...320480
	25	17	Hyper	100	15 9644 01*/**	...314090
	25	19	Hyper	100	15 9290 01*/**	...320497
	25	19	Ultrasoft	100	15 9339 01*/**	...493726
	25	21	Hyper	100	15 9292 01*/**	...320565
	25	21	Ultrasoft	100	15 9689 01*/**	...312584
	30	26	Hyper	100	15 9675 01*	...049459
	30	26	Ultrasoft	100	15 9673 01*	...312461
	20	10	Hyper	100	15 9275 01*/**	...320572
	20	10	Hyper	100	15 9277 01*/**	...320589
	20	12	Hyper	100	15 9278 01*/**	...320596
	20	13	Hyper	100	15 9280 01*/**	...320664
	20	13	Hyper	100	15 9281 01*/**	...320671
	20	14	Hyper	100	15 9283 01*/**	...320688
	20	15	Hyper	100	15 9284 01*/**	...320695
	20	16	Hyper	100	15 9285 01*/**	...320763
	20	17	Hyper	100	15 9288 01*/**	...320770
	25	17	Hyper	100	15 9289 01*/**	...320787
	25	19	Hyper	100	15 9291 01*/**	...320794
	25	21	Hyper	100	15 9293 01*/**	...320862
	25	21	Ultrasoft	100	15 9690 01*/**	...312676
	30	26	Hyper	100	15 9294 01*	...320879

Basis mit Gelenk und abgesetzem Kopf und Bund zum Einstecken in Rundrohre

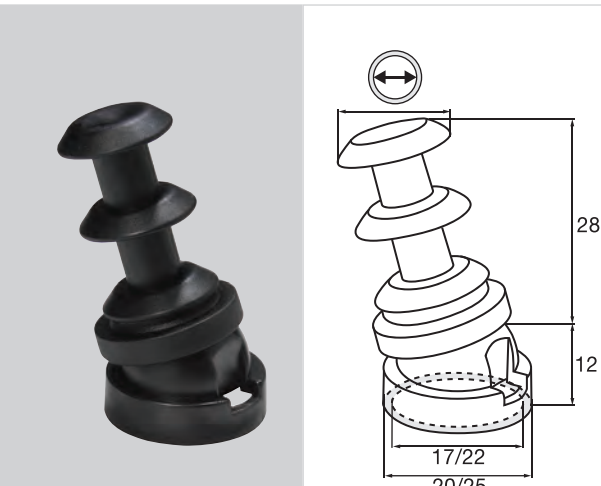
Base with articulation and shouldered head and collar for insertion into round tubes





Base avec articulation à tête décalée et manchon à enficher dans des tubes ronds

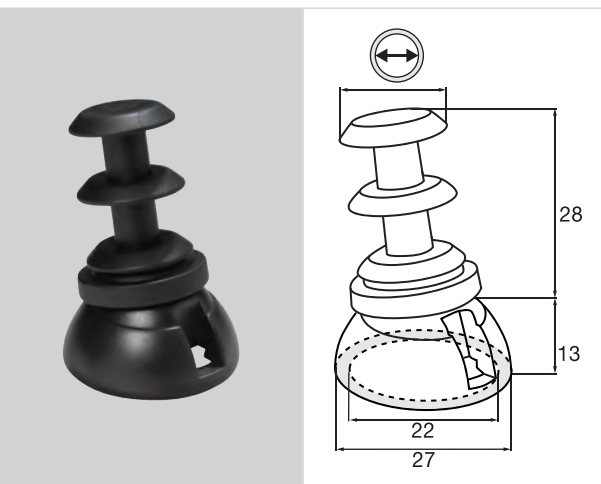

	Ø mm				pcs.	Code	EAN-Code 4001073 ...
	20	14/10	Hyper		100	15 9667 01*/**	...318869
	20	14/10	Ultrasoft		100	15 9386 01*/**	...322583
	20	16/10	Ultrasoft		100	15 9612 01*/**	...312997
	20	16/10	Hyper		100	15 9205 01*/**	...318975
	20	16/12	Ultrasoft		100	15 9362 01*/**	...322088
	20	16/12	Hyper		100	15 9204 01*/**	...318982
	20	18/14	Ultrasoft		100	15 9648 01*/**	...322187
	20	18/14	Hyper		100	15 9618 01*/**	...313499
	20	18/14	Ultrasoft		100	15 9682 01*/**	...450095
	20	18/14	Black		100	15 9627 01*/**	...450064
	20	20/16	Hyper		100	15 9203 01*/**	...320886
	20	20/16	Ultrasoft		100	15 9385 01*/**	...322491
	20	20/17	Hyper		100	15 9202 01*/**	...319071
	20	20/17	Ultrasoft		100	15 9384 01*/**	...322361
	20	20/17	Syno/Hyper		100	16 9212 01*/**	...396201
	25	20/16	Hyper		100	15 9668 01*/**	...318890
	25	20/17	Hyper		100	16 9642 01*/**	...330069
	25	20/17	Ultrasoft		100	16 9641 01*/**	...329995
	25	22/18	Ultrasoft		100	15 9390 01*/**	...323375
	25	22/18	Hyper		100	15 9635 01*/**	...313284
	25	22/19	Hyper		100	16 9635 01*/**	...331882
	25	25/21	Ultrasoft		100	15 9652 01*/**	...315875
	25	25/21	Hyper		100	15 9200 01*/**	...319095
	30	20/17	Hyper		100	15 9256 01*/**	...014846
	30	20/17	Ultrasoft		100	16 9204 01*	...330267
	30	22/18	Ultrasoft		100	16 9839 01*	...329285
	30	25/21	Hyper		100	15 9665 01*/**	...318777
	30	25/21	Ultrasoft		100	15 9662 01*	...318760
	20	14/10	Hyper		100	15 9295 01*/**	...320893
	20	16/10	Hyper		100	15 9296 01*/**	...320961
	20	16/12	Hyper		100	15 9297 01*/**	...320978
	20	18/14	Hyper		100	15 9298 01*/**	...320985
	20	20/16	Hyper		100	15 9299 01*/**	...324860
	20	20/17	Hyper		100	15 9240 01*/**	...321067
	25	22/18	Hyper		100	15 9241 01*/**	...321074
	25	25/21	Hyper		100	15 9242 01*/**	...321081
	20	16/10	Hyper		100	15 9243 01*/**	...321098

Basis mit Gelenk zum Einstecken in Rundrohre  
 Base with articulation for insertion into round tubes  
 Base avec articulation à enficher dans des tubes ronds



	Ø mm			pcs.	Code	EAN-Code 4001073 ...
	25	20/16	Hyper	100	15 9330 01*	...321180
	25	20/16	Ultrasoft	100	15 9331 01*	...321197

Kundenspezifischer Artikel hergestellt für  
 This article is produced exclusively for  
 Article spécifique fabriqué pour



Basis mit Gelenk, Kugel dreieckig, zum Einstecken in Rundrohre  
 Base with articulation, head triangular, for insertion into round tubes  
 Base avec articulation à tête triangulaire à enficher dans des tubes ronds

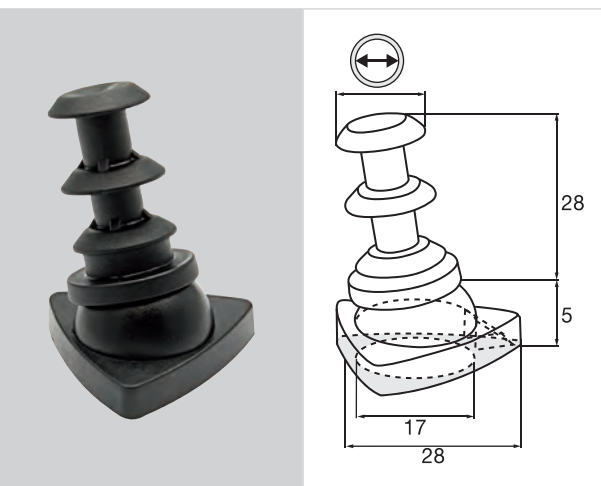

	Ø mm			pcs.	Code	EAN-Code 4001073 ...
	20	18/14	Hyper	100	15 9332 01*	...321265



Kundenspezifischer Artikel hergestellt für **WALTER KNOLL**  
 This article is produced exclusively for  
 Article spécifique fabriqué pour

Basis mit Gelenk (und Bund), Ringdesign superflach zum Einstecken in Rundrohre

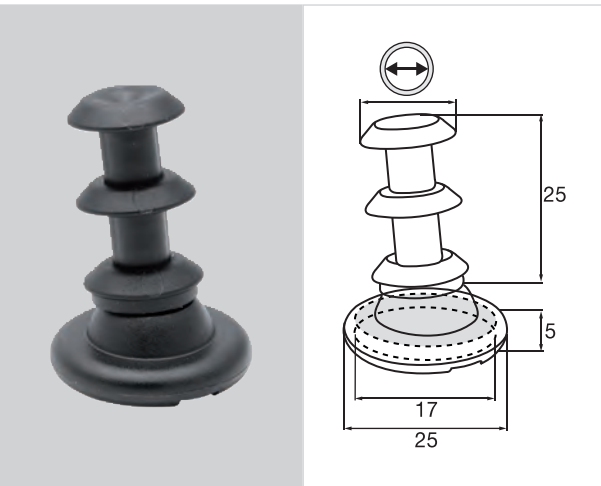

Base with articulation (and collar), ring design super flat for insertion into round tubes

Base avec articulation (et manchon), design bague extra plate à enficher dans des tubes ronds



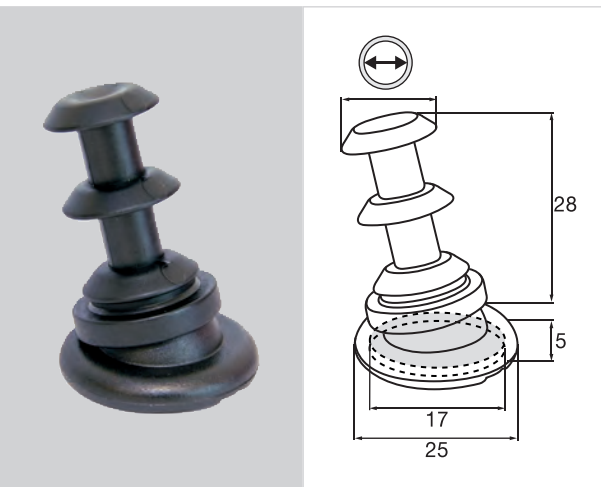



	Ø mm				pcs.	Code	EAN-Code 4001073 ...
	20	10	Hyper		100	15 9707 01*	...317381
	20	10	Hyper		100	15 9708 01*	... 317398
	20	12	Hyper		100	15 9709 01	...317466
	20	13	Hyper		100	15 9717 01*	...317473
	20	13	Hyper		100	15 9718 01*	...317480
	20	14	Hyper		100	15 9719 01	...317497
	20	15	Hyper		100	15 9720 01*	...317565
	20	16	Hyper		100	15 9721 01	...317572
	20	16	Ultrasoft		100	15 9393 01	...323597
	20	17	Hyper		100	15 9723 01*	...317589
	20	17	Hyper		100	15 9724 01*	...317596
	20	19	Hyper		100	15 9702 01	...316698
	20	21	Hyper		100	15 9726 01*	...317664



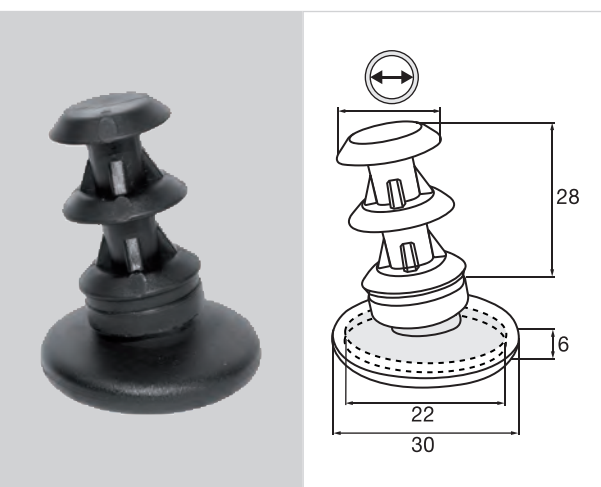
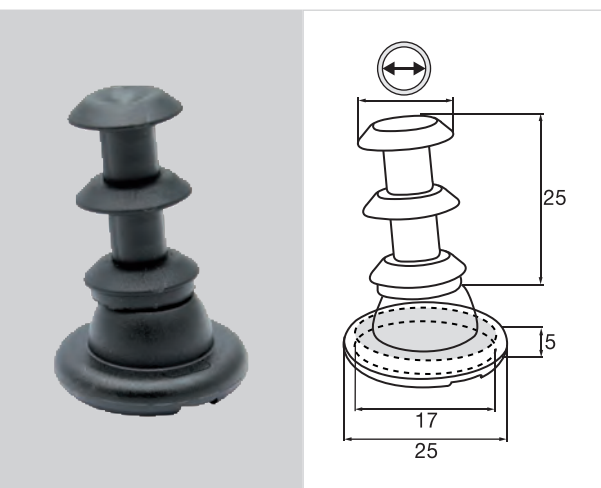

	Ø mm				pcs.	Code	EAN-Code 4001073 ...
	20	14/10	Hyper		100	15 9706 01*	...317374
	20	14/10	Ultrasoft		100	16 9700 01*	...146615
	20	16/10	Hyper		100	15 9788 01*	...316582
	20	16/10	Ultrasoft		100	15 9789 01*	...316599
	20	16/12	Hyper		100	15 9786 01*	...316568
	20	16/12	Ultrasoft		100	15 9787 01*	...316575
	20	18/14	Hyper		100	15 9780 01*	...316476
	20	18/14	Ultrasoft		100	15 9798 01*	...316667
	20	20/16	Hyper		100	15 9700 01*	...316674
	20	20/16	Ultrasoft		100	15 9701 01*	...316681
	20	20/17	Hyper		100	15 9704 01*	...317299
	20	22/18	Hyper		100	15 9784 01*	...315691
	20	22/18	Ultrasoft		100	15 9785 01*	...315769
	20	22/19	Ultrasoft		100	15 9703 01*	...316766
	20	25/21	Hyper		100	15 9705 01*	...317367

Basis mit Gelenk, Ringdesign flach zum Einstecken in Rundrohre  
 Base with articulation, ring design flat for insertion into round tubes  
 Base avec articulation, design bague plate à enficher dans des tubes ronds





	Ø mm				pcs.	Code	EAN-Code 4001073 ...
	20	10	Hyper		100	15 9796 01*	...321272
	20	10	Hyper		100	15 9353 01*	...321289
	20	12	Hyper		100	15 9354 01*	...321296
	20	13	Hyper		100	15 9355 01*	...321364
	20	13	Hyper		100	15 9356 01*	...321371
	20	14	Hyper		100	15 9357 01*	...321388
	20	15	Ultrasoft		100	16 0005 01*	...327663
	20	15	Hyper		100	15 9358 01*	...321395
	20	15	Hyper		100	15 9340 01*	...322484
	20	16	Hyper		100	15 9359 01*	...321463
	20	17	Hyper		100	15 9360 01*	...321470
	20	17	Hyper		100	15 9380 01*	...321487
	20	19	Hyper		100	15 9381 01*	...321494
	20	21	Hyper		100	15 9382 01*	...321562
	25	13	Ultrasoft		100	16 9355 01*	...328660

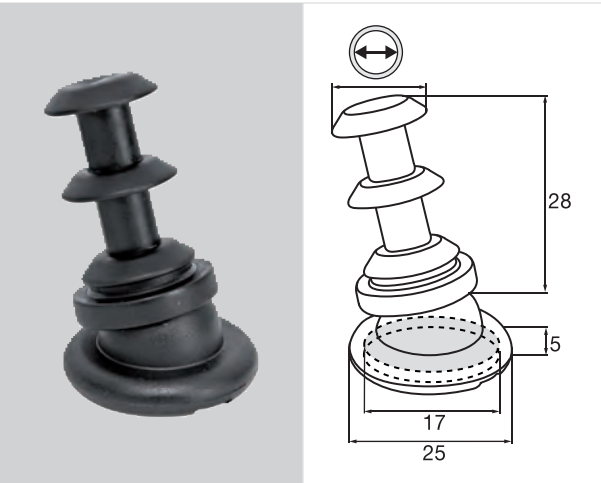

	Ø mm				pcs.	Code	EAN-Code 4001073 ...
	25	10	Hyper		100	15 9861 01*	...317794
	25	12	Hyper		100	15 9862 01*	...317862
	25	13	Hyper		100	15 9865 01*	...317886
	25	13	Ultrasoft		100	15 9405 01*	...327083
	25	13	Hyper		100	15 9864 01*	...317879
	25	14	Hyper		100	15 9866 01*/**	...317893
	25	14	Black		100	16 9866 01*	...331974
	25	15	Hyper		100	15 9867 01*	...317961
	25	16	Hyper		100	15 9868 01*	...317978
	25	17	Hyper		100	15 9869 01*	...317985
	25	17	Hyper		100	15 9877 01*	...317992
	25	19	Hyper		100	15 9878 01*	...318067
	25	21	Hyper		100	15 9894 01*	...318074
	25	26	Black		100	16 9772 01*	...454499
	25	26	Hyper		100	16 9770 01*	...455199
	25	26	Ultrasoft		100	16 9773 01*	...450088

Basis mit Gelenk, Ringdesign flach zum Einstecken in Rundrohre  
 Base with articulation, ring design flat for insertion into round tubes  
 Base avec articulation, design bague plate à enficher dans des tubes ronds

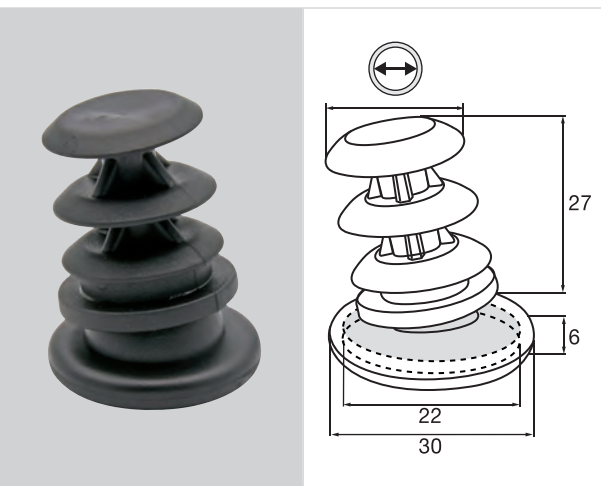

	Ø mm				pcs.	Code	EAN-Code 4001073 ...
	20	14/10	Ultrasoft		100	15 9222 01*	...325263
	20	14/10	Hyper		100	15 9791 01*	...318876
	20	16/10	Ultrasoft		100	15 9731 01*	...308785
	20	16/10	Hyper		100	15 9730 01*	...308570
	20	16/12	Ultrasoft		100	15 9781 01*	...315592
	20	16/12	Hyper		100	15 9732 01*	...308679
	20	18/14	Ultrasoft		100	15 9769 01*	...313987
	20	18/14	Hyper		100	15 9783 01*	...315677
	20	20/16	Ultrasoft		100	15 9737 01*	...309584
	20	20/16	Hyper		100	15 9729 01*	...312065
	20	20/17	Ultrasoft		100	15 9739 01*	...310290
	20	20/17	Hyper		100	15 9738 01*	...307795
	20	22/18	Hyper		100	15 9743 01*	...313192
	20	22/19	Ultrasoft		100	15 9741 01*	...313260
	20	22/19	Hyper		100	15 9767 01*	...313567
	20	25/21	Ultrasoft		100	15 9763 01*	...312690
	20	25/21	Hyper		100	15 9711 01*	...319293



	Ø mm				pcs.	Code	EAN-Code 4001073 ...
	25	14/10	Hyper		100	15 9860 01*	...317877
	25	16/10	Hyper		100	15 9774 01*	...315585
	25	16/12	Ultrasoft		100	16 0007 01*	...221749
	25	16/12	Hyper		100	15 9775 01*	...315684
	25	18/14	Hyper		100	15 9855 01*	...317671
	25	18/14	Ultrasoft		100	16 0013 01*	...328677
	25	20/16	Hyper		100	15 9856 01*	...317688
	25	20/16	Ultrasoft		100	16 9750 01*	...155983
	25	20/17	Hyper		100	15 9857 01*	...317695
	25	22/18	Hyper		100	15 9858 01*	...317763
	25	22/18	Ultrasoft		100	16 0029 01*	...493849
	25	22/19	Ultrasoft		100	15 9246 01*	...322996
	25	25/21	Hyper		100	15 9859 01*	... 317770
	25	22/19	Hyper		100	15 9245 01*	...322989





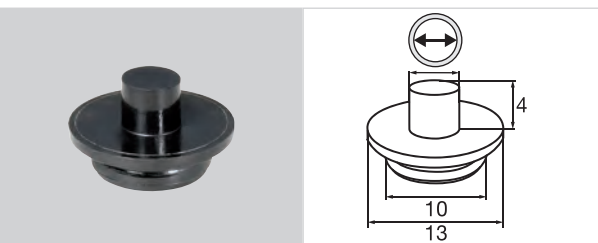

Basis „FILIGRANO” zum Einstecken in Rundrohre  
 Base „FILIGRANO” for insertion into round tubes  
 Base „FILIGRANO” à enficher dans des tubes ronds

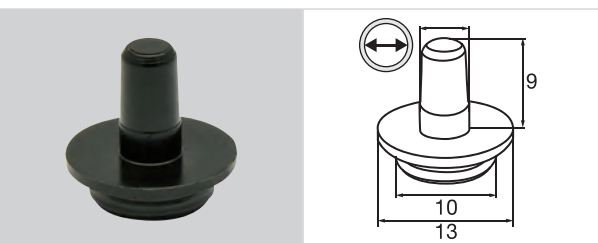





	Ø mm					pcs.	Code	EAN-Code 4001073 ...
	13	5				100	15 8089 01	...251654

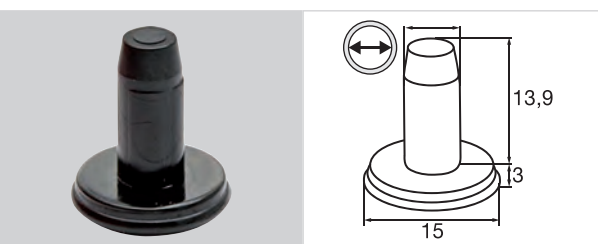





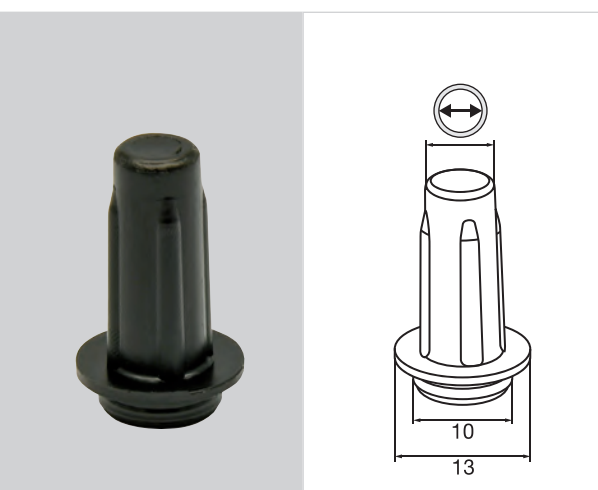

	Ø mm					pcs.	Code	EAN-Code 4001073 ...
	13	4,5				100	15 8055 01	...014136
	13	4,5				100	15 8073 01	...335194



	Ø mm					pcs.	Code	EAN-Code 4001073 ...
	17	6				100	15 8037 01	...000511
	17	6				100	15 8058 01	...017823







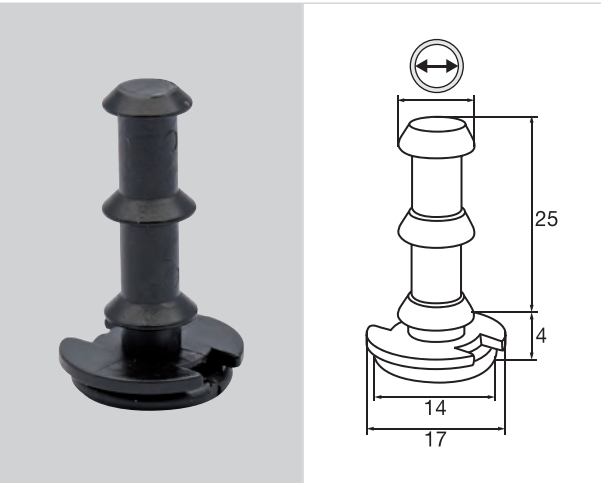

	Ø mm					pcs.	Code	EAN-Code 4001073 ...
	13	13/8	18			100	15 9342 01	...014211
	13	13/8,5	8			100	16 9400 01	...031386
	13	13/10	18			100	15 9324 01	...411959

Basis „FILIGRANO“ zum Einstecken in Rundrohre

Base „FILIGRANO“ for insertion into round tubes

Base „FILIGRANO“ à enficher dans des tubes ronds



	Ø mm					pcs.	Code	EAN-Code 4001073 ...
	17	17/6				100	15 9903 01	...322569
	17	17/7				100	15 9923 01	...322576
	17	17/8				100	15 9902 01	...322774
	17	17/9				100	15 9921 01	...322781

Basis „SILENCER FILIGRANO“ zum Einstecken in Rundrohre

Base „SILENCER FILIGRANO“ for insertion into round tubes

Base „SILENCER FILIGRANO“ à enficher dans des tubes ronds

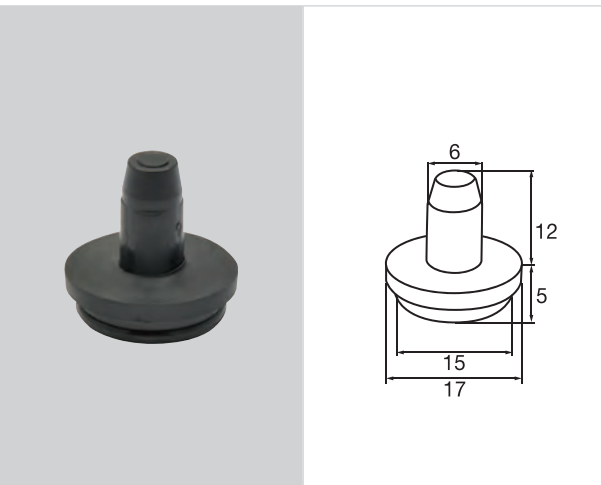





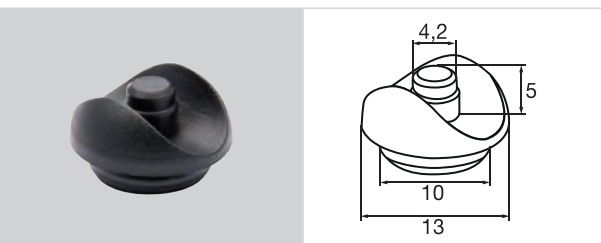

	Ø mm					pcs.	Code	EAN-Code 4001073 ...
	17	17/6				100	15 8063 01	...053531

Basis „FILIGRANO” zum Einstecken in filigrane Drahtgestelle





Base „FILIGRANO” for insertion into filigree wire frames

Base „FILIGRANO” à enficher dans des piètements en acier filigrans

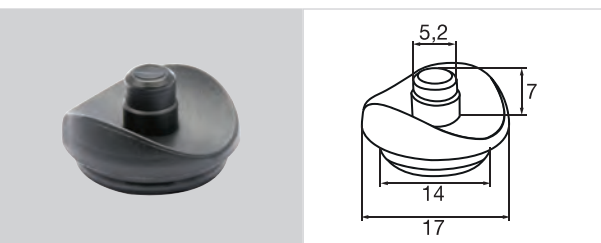





	Ø mm					pcs.	Code	EAN-Code 4001073 ...
	13	8				100	16 8036 01	...222036
	13	10				100	16 8037 01	...420036
	13	12				100	16 8038 01	...419641

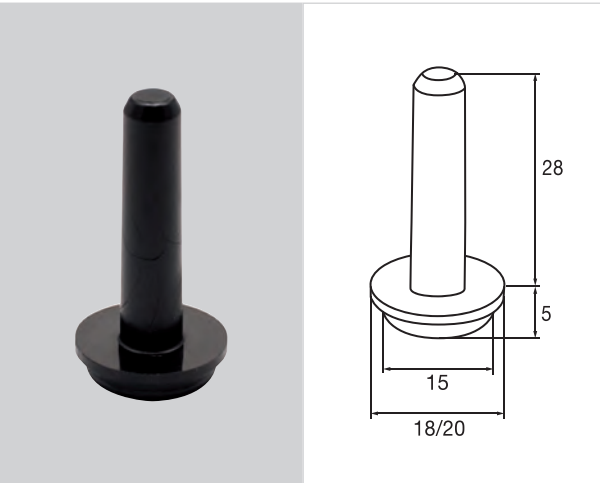

	Ø mm					pcs.	Code	EAN-Code 4001073 ...
	17	14				100	16 8039 01	...222623
	17	16				100	16 8040 01	...419634
	17	18				100	16 8041 01	...222128

Basis „SILENCER SLIM“ zum Einstecken in passende Absorber  
 Base „SILENCER SLIM“ for insertion into suitable absorbers  
 Base „SILENCER SLIM“ á enficher dans des absorbeurs appropriés



	Ø mm					pcs.	Code	EAN-Code 4001073 ...
	17	18				100	15 9343 01	...324488
	20	20				100	15 9344 01	...324495

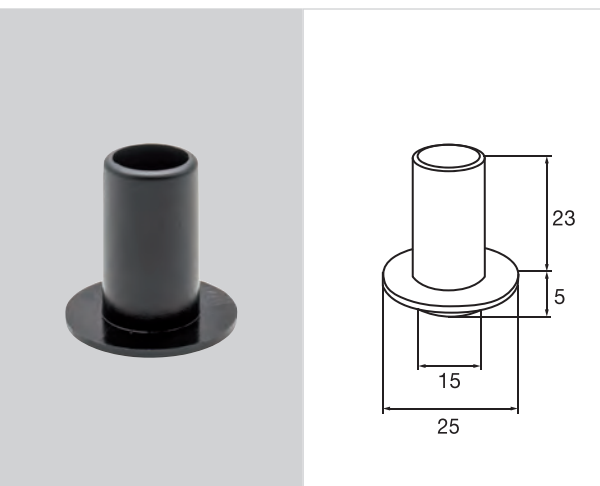

	Ø mm					pcs.	Code	EAN-Code 4001073 ...
	25	25				100	15 9345 01	...324563

Basis „SILENCER“ mit Gelenk und abgesetztem Kopf zum Einstecken in passende Absorber

Base „SILENCER“ with articulation and shouldered head for insertion into suitable absorbers

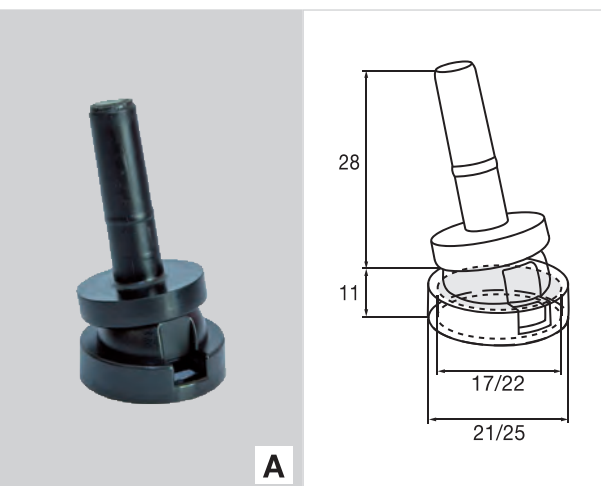

Base „SILENCER“ avec articulation décalée à enficher dans des absorbeurs appropriés



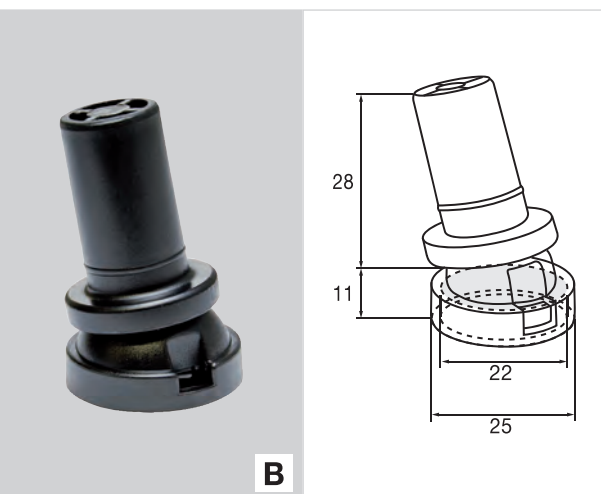

A



B

	Ø mm				pcs.	Code	EAN-Code 4001073 ...
	17	16			100	16 9943 01	...352542
	17	18	Ultrasoft		100	15 0952 01*/**	...223200
	17	18	Hyper		100	15 0951 01*/**	...325799
	20	16	Ultrasoft		100	15 9946 01*/**	...312485
	20	16	Hyper		100	15 9947 01*/**	...312492
	20	18	Ultrasoft		100	15 9943 01*/**	...311372
	20	18	Hyper		100	15 9944 01*/**	...311389
	20	20	Ultrasoft		100	15 9953 01*/**	...311488
	20	20	Hyper		100	15 9954 01*/**	...311495
	25	20	Ultrasoft		100	15 9939 01*/**	...312362
	25	20	Hyper		100	15 9966 01*/**	...312379
	30	18	Ultrasoft		100	15 9656 01*/**	...316988
	30	18	Hyper		100	15 9655 01*/**	...316971
	30	20	Hyper		100	15 9221 01*/**	...325195









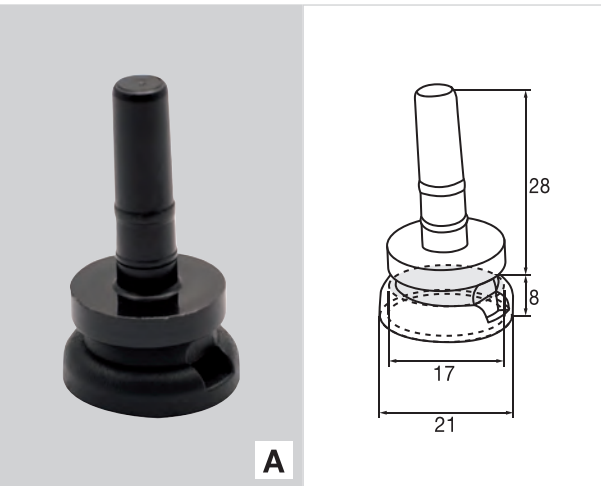

	Ø mm				pcs.	Code	EAN-Code 4001073 ...
	25	22	Ultrasoft		100	15 9963 01*/**	...311594
	25	22	Hyper		100	15 9964 01*/**	...311662
	25	25	Ultrasoft		100	15 9909 01*/**	...318470
	25	25	Hyper		100	15 9914 01*/**	...318487
	30	22	Ultrasoft		100	15 9223 01*/**	...325980
	30	22	Hyper		100	15 9224 01*/**	...325997

Basis „SILENCER 20“ mit Gelenk, Ringdesign superflach zum Einstecken in passende Absorber

Base „SILENCER 20“ with articulation and ring design super flat for insertion into suitable absorbers

Base “SILENCER 20” avec articulation, design bague extra plate à enficher dans des absorbeurs appropriés



	Ø mm				pcs.	Code	EAN-Code 4001073 ...
	20	16	Ultrasoft		100	15 0943 01*	...323887
	20	16	Hyper		100	15 0942 01*	...323795
	20	18	Ultrasoft		100	15 9347 01*	...323573
	20	18	Hyper		100	15 9389 01*	...323191
	20	18	Hyper		100	16 9388 01*	...419405
	20	20	Ultrasoft		100	15 0946 01*	...323962
	20	20	Hyper		100	15 0945 01*	...323894
	20	20	Ultrasoft		100	15 9365 01*	...014730



Basis „SILENCER 25/30“ mit Gelenk, Ringdesign superflach zum Einstecken in passende Absorber

Base „SILENCER 25/30“ with articulation and ring design super flat for insertion into suitable absorbers

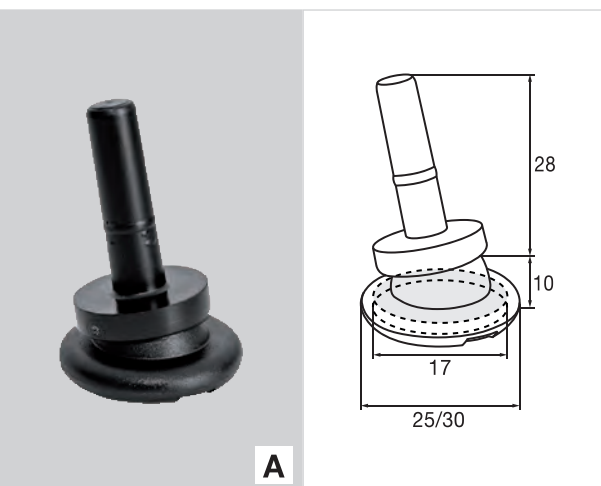
Base “SILENCER 25/30” avec articulation, design bague extra plate à enficher dans des absorbeurs appropriés



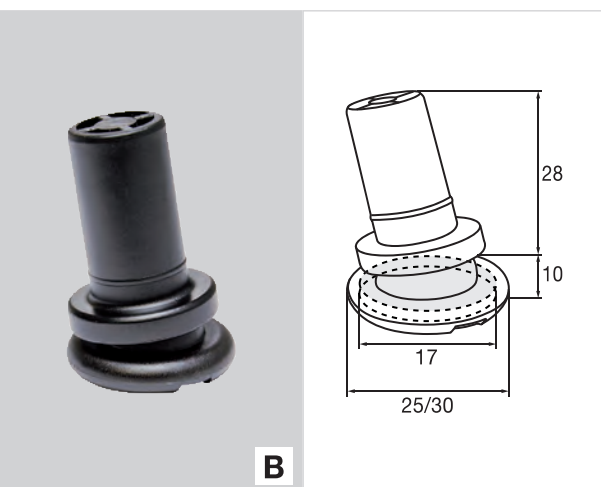

**A**

	Ø mm				pcs.	Code	EAN-Code 4001073 ...
	20	16	Ultrasoft		100	15 9986 01*	...315899
	20	16	Hyper		100	15 9989 01*	...316063
	20	18	Ultrasoft		100	15 9910 01*	...316087
	20	18	Hyper		100	15 9987 01*	...315981
	20	20	Ultrasoft		100	15 9912 01*	...316162
	20	20	Hyper		100	15 9988 01*	...315998
	25	16	Ultrasoft		100	15 0931 01*	...324082
	25	16	Hyper		100	16 0942 01*	...328684
	25	18	Ultrasoft		100	15 0933 01*	...324266
	25	18	Hyper		100	15 0934 01*	...324273
	25	20	Ultrasoft		100	15 0935 01*	...324280
	25	20	Hyper		100	15 0936 01*	...324297



**B**

	Ø mm				pcs.	Code	EAN-Code 4001073 ...
	20	22	Ultrasoft		100	15 9913 01*	...316773
	20	22	Hyper		100	15 9911 01*	...316094
	20	25	Ultrasoft		100	15 9915 01*	...318494
	20	25	Hyper		100	15 9916 01*	...318562
	25	22	Ultrasoft		100	15 0937 01*	...324365
	25	22	Hyper		100	15 0938 01*	...324372
	25	25	Ultrasoft		100	15 0939 01*	...324389
	25	25	Hyper		100	15 0940 01*	...324471

Basis „SILENCER 25“ mit Gelenk, Ringdesign flach zum Einstecken in passende Absorber

Base „SILENCER 25“ with articulation and ring design flat for insertion into suitable absorbers



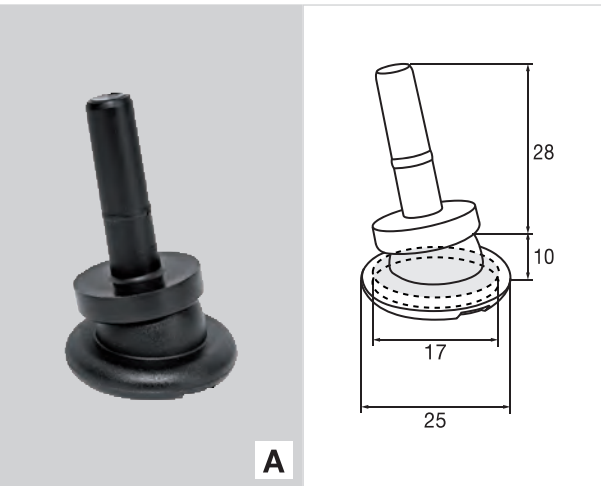



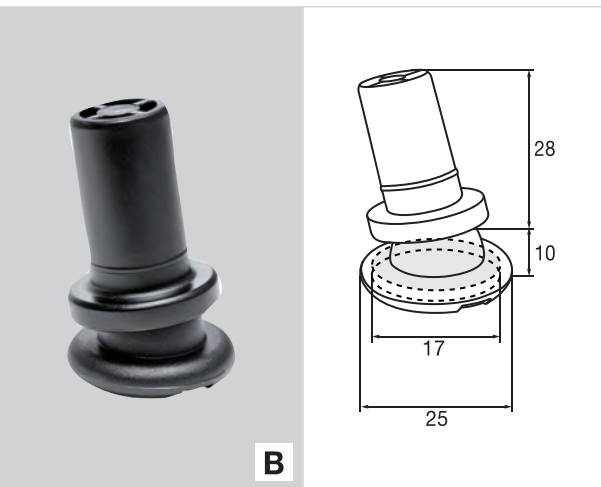

Base “SILENCER 25” avec articulation, design bague plate à enficher dans des absorbeurs appropriés









**A**



**B**

	Ø mm				pcs.	Code	EAN-Code 4001073 ...
	20	16	Ultrasoft		100	15 9979 01*	...315073
	20	16	Hyper		100	15 9978 01*	...315080
	20	18	Ultrasoft		100	15 9985 01*	...314465
	20	18	Hyper		100	15 9982 01*	...313871
	20	20	Ultrasoft		100	15 9984 01*	...313895
	20	20	Hyper		100	15 9981 01*	...313864

	Ø mm				pcs.	Code	EAN-Code 4001073 ...
	20	22	Ultrasoft		100	15 9983 01*	...313888
	20	22	Hyper		100	15 9980 01*	...313796
	20	25	Ultrasoft		100	15 9917 01*	...318579
	20	25	Hyper		100	15 9918 01*	...318586









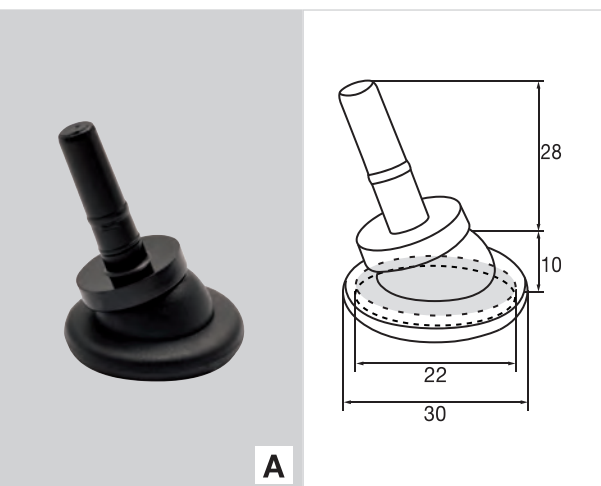

Basis „SILENCER 30“ mit Gelenk, Ringdesign flach zum Einstecken in passende Absorber





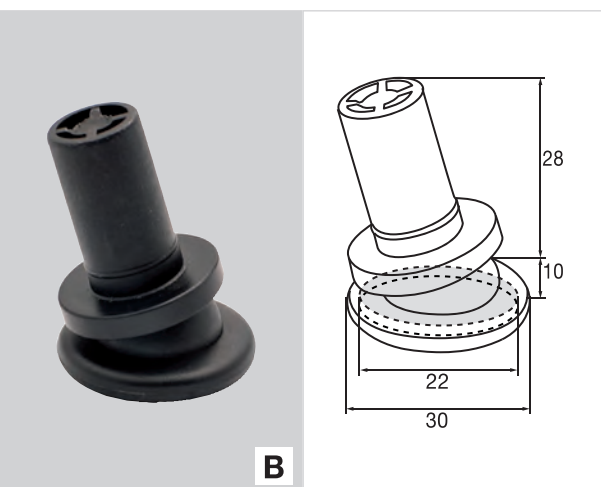

Base „SILENCER 30“ with articulation and ring design flat for insertion into suitable absorbers

Base “SILENCER 30” avec articulation, design bague plate à enficher dans des absorbeurs appropriés



	Ø mm				pcs.	Code	EAN-Code 4001073 ...
	25	16	Ultrasoft		100	15 9977 01*	...315097
	25	16	Hyper		100	15 9976 01*	...315165
	25	18	Ultrasoft		100	15 9975 01*	...315172
	25	18	Hyper		100	15 9974 01*	...315189
	25	20	Ultrasoft		100	15 9973 01*	...315264
	25	20	Hyper		100	15 9972 01*	...315271





	Ø mm				pcs.	Code	EAN-Code 4001073 ...
	25	22	Ultrasoft		100	15 9971 01*	...315288
	25	22	Hyper		100	15 9970 01*	...315295
	25	25	Ultrasoft		100	15 9919 01*	...318593
	25	25	Hyper		100	15 9920 01*	...318661

Absorber für „SILENCER“ Typ A (ohne Zapfen)

Absorber for „SILENCER“ type A (without pin)

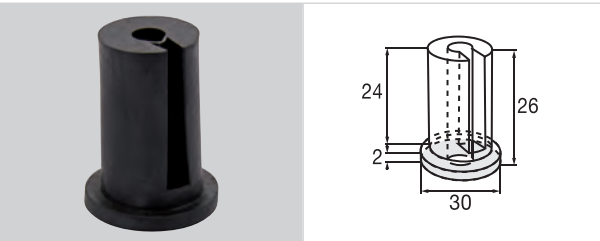
Absorbeur pour „SILENCER“ type A (sans maneton)





						pcs.	Code	EAN-Code 4001073 ...
								
						100	15 9929 01	...313185
						100	15 8924 01	...324099
						100	15 9930 01	...310498
						100	16 9930 01	...327373
						100	15 9933 01	...311181

Absorber für „SILENCER“ Typ A (mit Zapfen)

Absorber for „SILENCER“ type A (with pin)

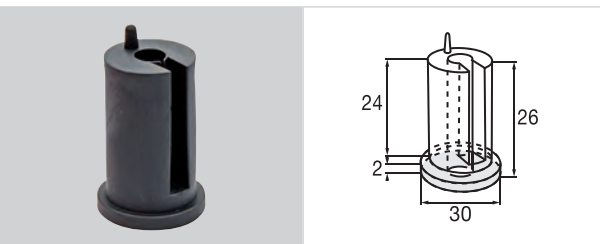
Absorbeur pour „SILENCER“ type A (avec maneton)





						pcs.	Code	EAN-Code 4001073 ...
								
						100	15 9928 01	...312386
						100	15 9931 01	...310474
						100	15 9934 01	...311198

Absorber für „SILENCER“ Typ A

Absorber for „SILENCER“ type A

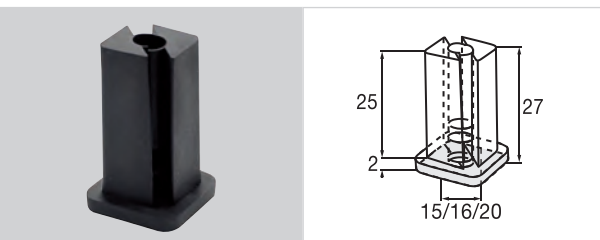
Absorbeur pour „SILENCER“ type A





						pcs.	Code	EAN-Code 4001073 ...
								
						100	15 9927 01	...323474
						100	16 9915 01	...412208
						100	15 9906 01	...412154

Absorber für „SILENCER“ Typ B (ohne Zapfen)

Absorber for „SILENCER“ type B (without pin)

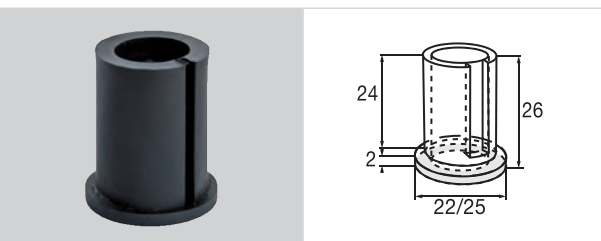
Absorbeur pour „SILENCER“ type B (sans maneton)





						pcs.	Code	EAN-Code 4001073 ...
								
	22/17					100	15 9938 01	...312898
	22/18					100	15 9936 01	...311266
	25/20					100	15 9937 01	...311273

Absorber für „SILENCER“ Typ B (mit Zapfen)

Absorber for „SILENCER“ type B (with pin)

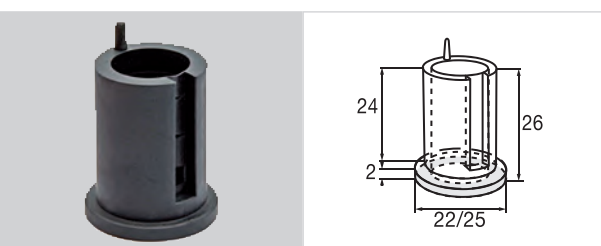
Absorbeur pour „SILENCER“ type B (avec maneton)





						pcs.	Code	EAN-Code 4001073 ...
								
	22/18,6					100	15 9935 01	...311884
	25/21					100	15 9932 01	...312393

Absorber für „SILENCER“ Typ B (mit 2 Zapfen)

Absorber for „SILENCER“ type B (with 2 pins)

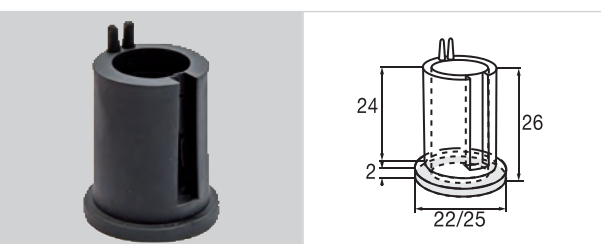
Absorbeur pour „SILENCER“ type B (avec 2 manetons)







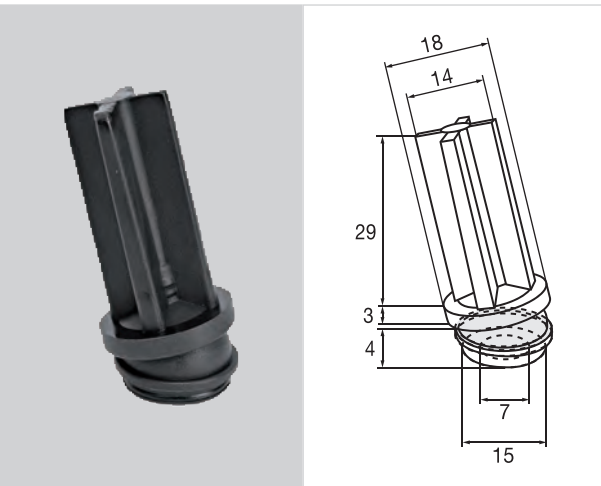

						pcs.	Code	EAN-Code 4001073 ...
								
	22/19,2					100	15 9926 01	...313963
	25/22					100	15 9924 01	...318289

Basis mit Gelenk, abgesetztem Kopf und Bund zum Einstecken in Rundrohre

Base with articulation, shouldered head and collar for insertion into round tubes

Base avec articulation à tête décalée et manchon à enficher dans des tubes ronds









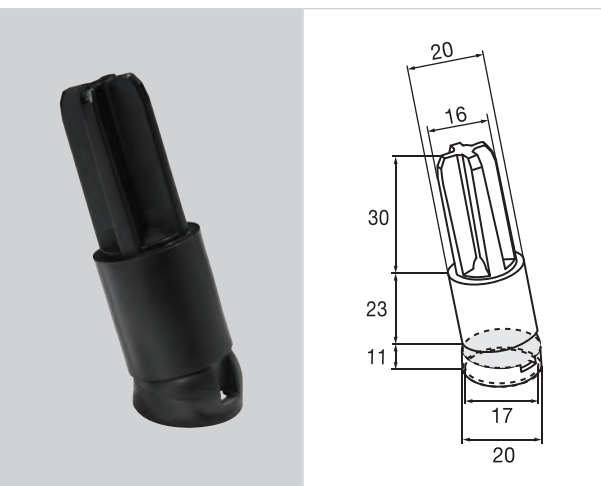

	Ø mm			pcs.	Code	EAN-Code 4001073 ...
	17	18/14	Hyper	100	15 9715 01*	...316261
	17	18/14	Ultrasoft	100	15 9716 01*	...316278

Basis mit Gelenk zum Einstecken in Rundrohre

Base with articulation for insertion into round tubes

Base avec articulation à enficher dans des tubes ronds







	Ø mm			pcs.	Code	EAN-Code 4001073 ...
	20	20/16	Hyper	100	15 9383 01*/**	...321579
	20	20/16	Ultrasoft	100	15 9373 01*/**	...321784
	20	20/16	Hyper	100	15 9375 01*/**	...321869
	20	20/16	Ultrasoft	100	15 9375 01*/**	...321791

Kundenspezifischer Artikel hergestellt für  
This article is produced exclusively for  
Article spécifique fabriqué pour

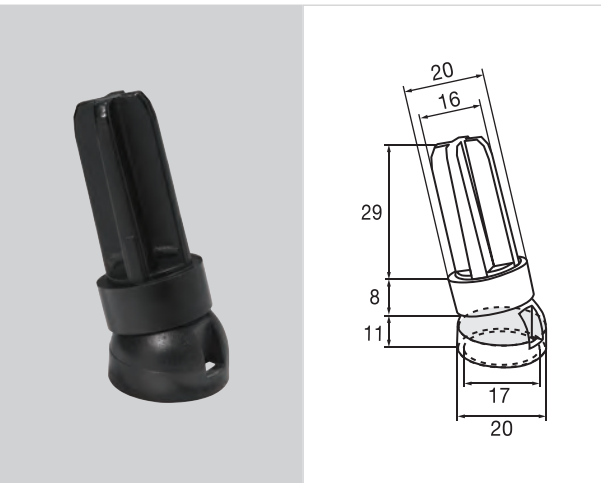
**girsberger**



Basis mit Gelenk zum Einstecken in Rundrohre  
 Base with articulation for insertion into round tubes  
 Base avec articulation à enficher dans des tubes ronds

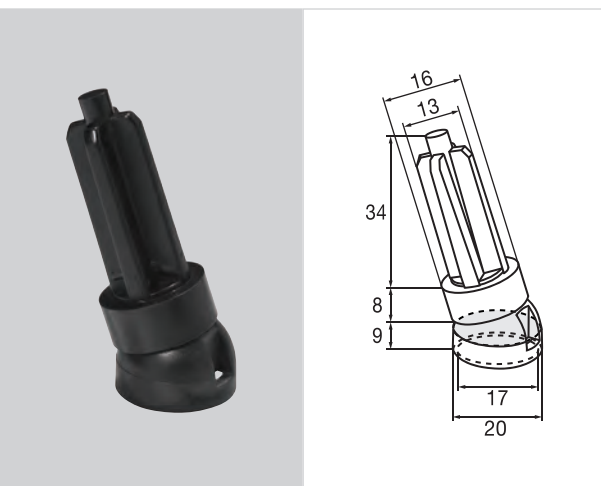

	Ø mm			pcs.	Code	EAN-Code 4001073 ...
■	20	18/14	Hyper	100	15 9366 01*/**	...321593
■	20	18/14	Ultrasoft	100	15 9367 01*/**	...321661
■	20	18/14	Hyper	100	15 9376 01*/**	...321876
■	20	18/14	Ultrasoft	100	15 9377 01*/**	...321883

Kundenspezifischer Artikel hergestellt für **girsberger**  
 This article is produced exclusively for  
 Article spécifique fabriqué pour



	Ø mm			pcs.	Code	EAN-Code 4001073 ...
■	20	18/13	Hyper	100	15 9368 01*/**	...321678
■	20	18/13	Ultrasoft	100	15 9369 01*/**	...321685





Kundenspezifischer Artikel hergestellt für **girsberger**  
 This article is produced exclusively for  
 Article spécifique fabriqué pour

Basis mit Gelenk/Adapter zur Verlängerung zum Einstecken in Rundrohre

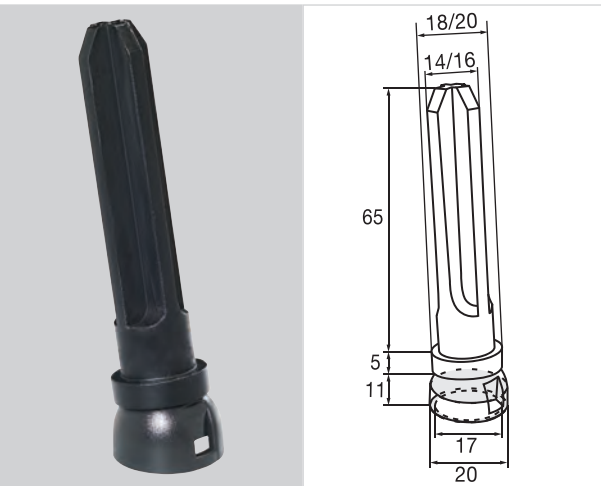



Base with articulation/adapter for extension for insertion into round tubes

Base avec articulation/adaptateur pour prolongement à enficher dans des tubes ronds

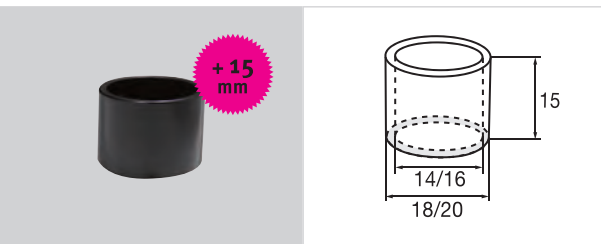





				pcs.	Code	EAN-Code 4001073 ...
	20	18/14	Hyper	100	15 9370 01*/**	...321692
	20	20/16	Hyper	100	15 9371 01*/**	...321760

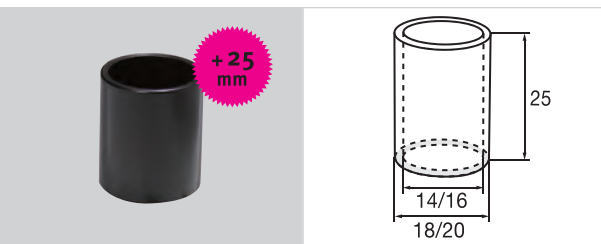

					pcs.	Code	EAN-Code 4001073 ...
	18/14				100	15 9750 01	...310580
	20/16				100	15 9752 01	...310665







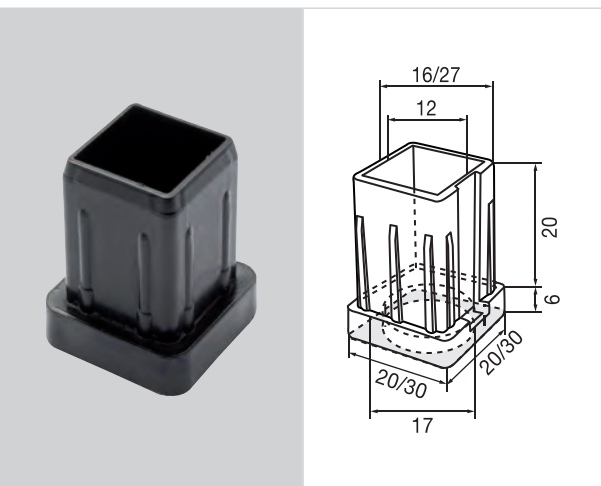

					pcs.	Code	EAN-Code 4001073 ...
	18/14				100	15 9751 01	...310597
	20/16				100	15 9753 01	...310672

Basis „QUATTRO” zum Einstecken in Vierkantrohre





Base „QUATTRO” for insertion into square tubes

Base „QUATTRO” à enficher dans des tubes de section carrée

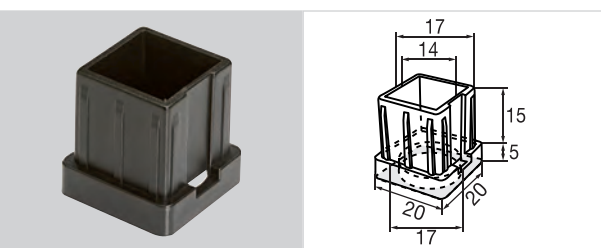

	Ø mm					pcs.	Code	EAN-Code 4001073 ...
	20	16x16				100	15 9014 01**	...312782
	30	27x27				100	15 9022 01**	...315967
	30	26x26				100	15 9065 01**	...326666
	30	26x26				100	15 9066 01**	...326888





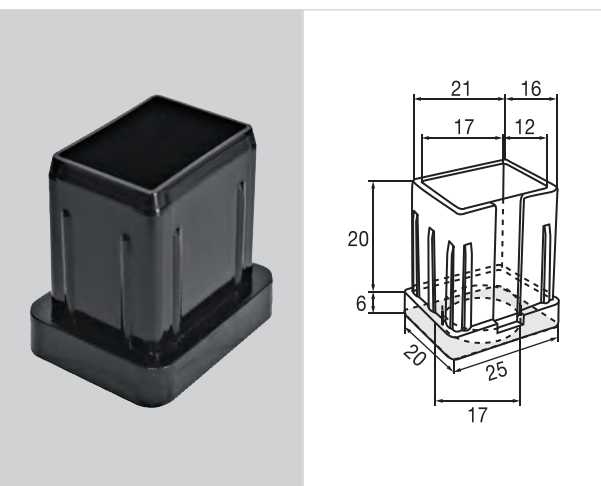

	Ø mm					pcs.	Code	EAN-Code 4001073 ...
	20	17x17				100	15 9015 01**	...309560
	20	17x17				100	15 9017 01**	...315974



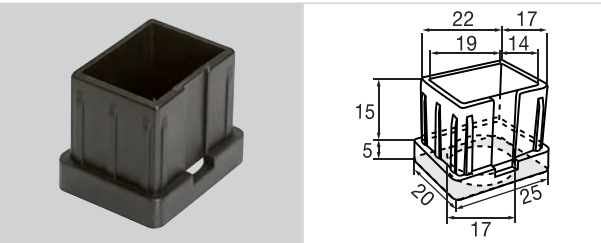



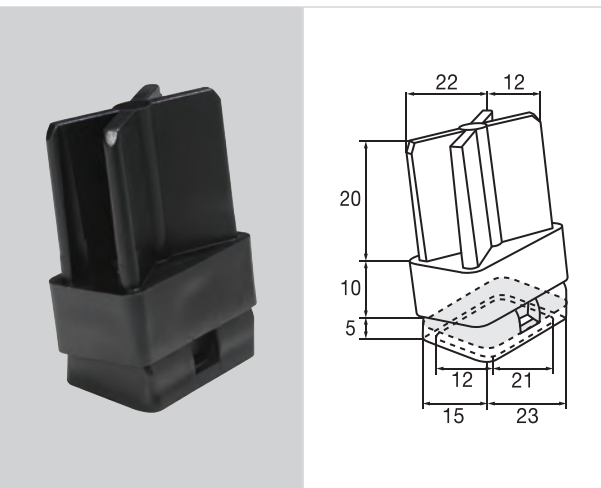

	Ø mm					pcs.	Code	EAN-Code 4001073 ...
	20	21x16				100	15 9019 01**	...595093

Basis „QUATTRO” zum Einstecken in Vierkantrohre  
 Base „QUATTRO” for insertion into square tubes  
 Base „QUATTRO” à enficher dans des tubes de section carrée



	Ø mm					pcs.	Code	EAN-Code 4001073 ...
	20	22x17				100	15 9016 01**	...309577
	20	22x17				100	15 9018 01**	...323290



	Ø mm					pcs.	Code	EAN-Code 4001073 ...
	23x15	22x12	Hyper			100	15 9372 01*	...321777
	23x15	22x12	Ultrasoft			100	15 8900 01*	...306392

Basis mit Hülse zum Einstecken in Vierkantrohre  
 Base with bush for putting into square tubes  
 Base avec douille à enficher dans tubes carrés

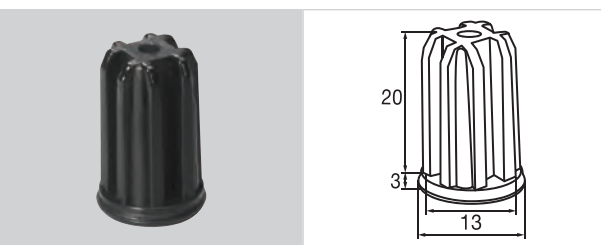



	Ø mm					pcs.	Code	EAN-Code 4001073 ...
	17	15x15				100	15 9905 01	...306880

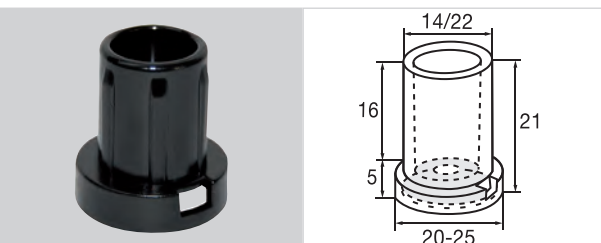

Basis mit Hülse zum Einstecken in z.B. Rundrohre  
 Base with bush for putting into e.g. round tubes  
 Base avec douille à enficher par ex. dans tubes ronds



	Ø mm					pcs.	Code	EAN-Code 4001073 ...
■	20	18/14				100	15 9000 01**	...298376
■	20	20/16				100	15 9001 01**	...298383
■	20	22/18				100	15 9002 01**	...298390
■	25	25/20				100	15 9004 01**	...307771
■	25	25/22				100	15 9003 01**	...298468
■	20	18/14				100	15 9010 01**	...298475
■	20	20/16				100	15 9011 01**	...298482
■	20	22/18				100	15 9012 01**	...298499
■	25	25/20				100	15 8999 01**	...316896
■	25	25/22				100	15 9013 01**	...298567
■	20	18/14				100	15 9006 01**	...314687
■	25	25/20				100	15 9005 01**	...306798
■	20	20/16				100	15 9007 01**	...314694
■	20	22/18				100	15 9008 01**	...314762
■	25	25/22				100	15 9021 01**	...314779

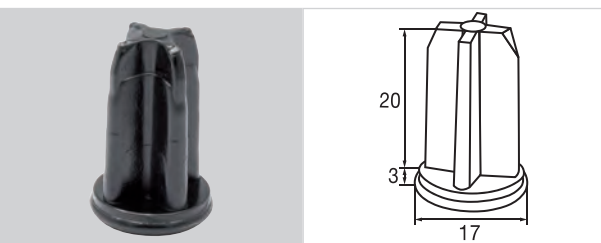

	Ø mm					pcs.	Code	EAN-Code 4001073 ...
■	17	16/12				100	15 9904 01	...306873

Basis zum Einstecken in Rundrohre  
 Base for insertion into round tubes  
 Base à enficher dans des tubes ronds

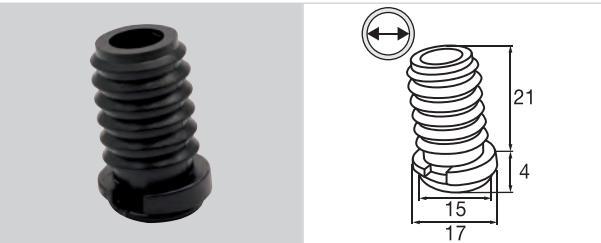

	Ø mm					pcs.	Code	EAN-Code 4001073 ...
	17	18/14				100	15 9310 01	...595666

Kundenspezifischer Artikel hergestellt für **WALTER KNOLL**  
 This article is produced exclusively for  
 Article spécifique fabriqué pour

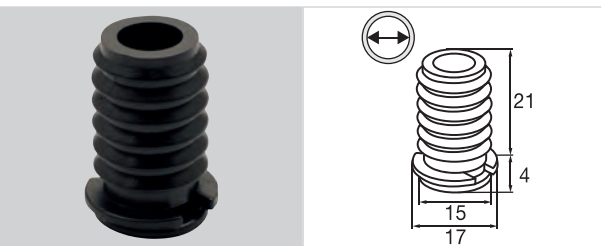

	Ø mm					pcs.	Code	EAN-Code 4001073 ...
	17	18/14				100	15 9311 01	...595673

Kundenspezifischer Artikel hergestellt für **WALTER KNOLL**  
 This article is produced exclusively for  
 Article spécifique fabriqué pour

Basis zum Einstecken für vorne und hinten  
 Base for insertion for front and back  
 Base à enficher de l'avant et l'arrière

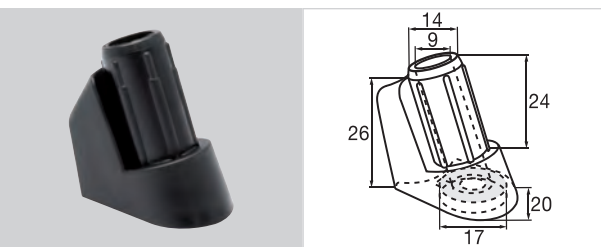

	Ø mm					pcs.	Code	EAN-Code 4001073 ...
	20	18/14				100	15 9308 01	...595475

Kundenspezifischer Artikel hergestellt für **brunner ::**  
 This article is produced exclusively for  
 Article spécifique fabriqué pour

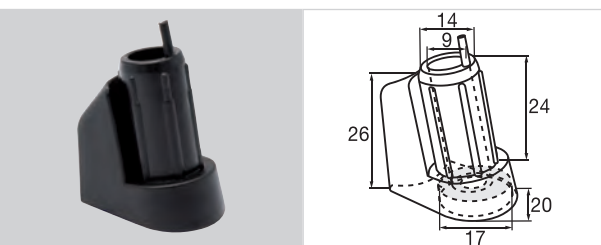

	Ø mm					pcs.	Code	EAN-Code 4001073 ...
	20	18/14				100	15 9302 01	...595468

Kundenspezifischer Artikel hergestellt für **brunner ::**  
 This article is produced exclusively for  
 Article spécifique fabriqué pour

Basis zum Einstecken für vorne und hinten

Base for insertion for front and back

Base à enficher de l'avant et l'arrière

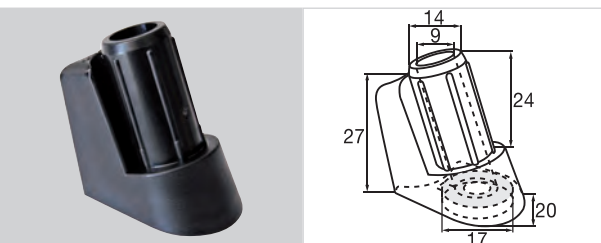

	Ø mm					pcs.	Code	EAN-Code 4001073 ...
	20	18/14				100	15 9321 01	...596267

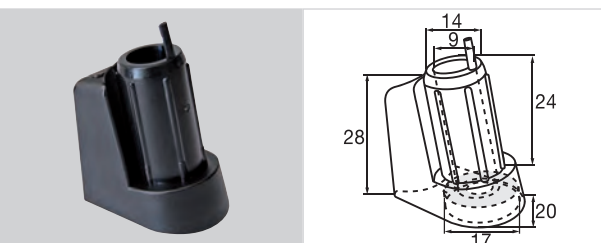

	Ø mm					pcs.	Code	EAN-Code 4001073 ...
	20	18/14				100	15 9322 01	...596274



	Ø mm					pcs.	Code	EAN-Code 4001073 ...
	20	18/14				100	15 9319 01	...595697

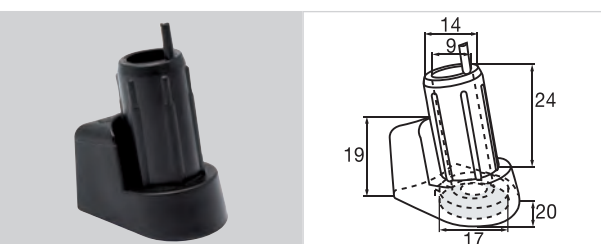

	Ø mm					pcs.	Code	EAN-Code 4001073 ...
	20	18/14				100	15 9320 01	...595680

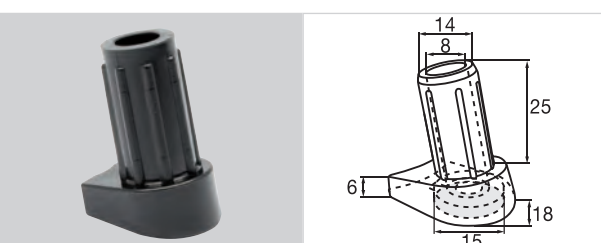

	Ø mm					pcs.	Code	EAN-Code 4001073 ...
	20	18/14				100	16 9324 01	...038460

Kundenspezifischer Artikel hergestellt für  
This article is produced exclusively for  
Article spécifique fabriqué pour

**brunner ::**

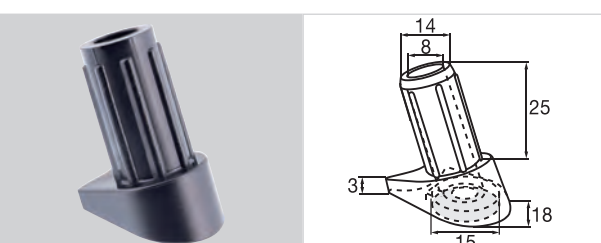

	Ø mm					pcs.	Code	EAN-Code 4001073 ...
	20	18/14				100	16 9323 01	...420241

Kundenspezifischer Artikel hergestellt für  
This article is produced exclusively for  
Article spécifique fabriqué pour

**brunner ::**

Basis zum Aufstecken für vorne und hinten  
 Base for attaching in front and back  
 Base capuchon à enficher de l'avant et l'arrière

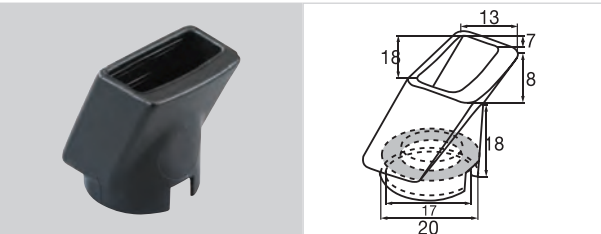

	Ø mm					pcs.	Code	EAN-Code 4001073 ...
	20	18/17				100	15 9300 01	...595260

Kundenspezifischer Artikel hergestellt für **interstuhl**  
 This article is produced exclusively for  
 Article spécifique fabriqué pour

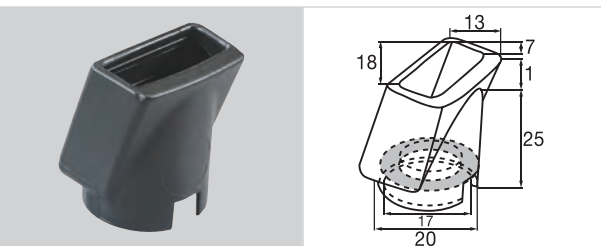

	Ø mm					pcs.	Code	EAN-Code 4001073 ...
	17	18/14				100	15 9301 01	...595277

Kundenspezifischer Artikel hergestellt für **interstuhl**  
 This article is produced exclusively for  
 Article spécifique fabriqué pour

Basis zum Einstecken in Rund-/Vierkantrohre  
 Base for insertion into round/square tubes  
 Base à enficher dans tubes ronds/carrés

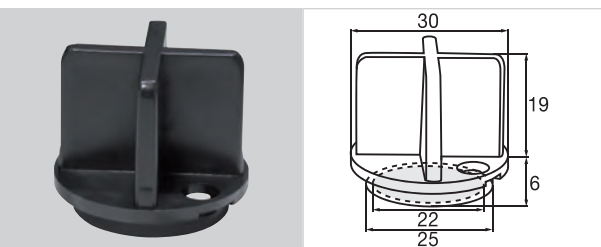

	Ø mm					pcs.	Code	EAN-Code 4001073 ...
	25	30/27				100	15 9080 01	...300772

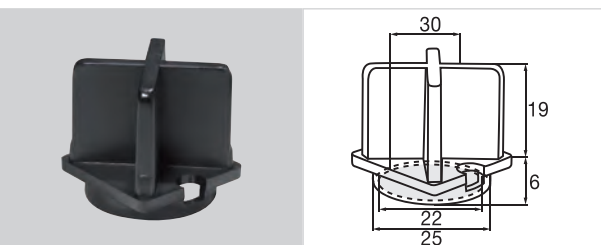

	Ø mm					pcs.	Code	EAN-Code 4001073 ...
	25	25/22				100	15 9085 01	...300789

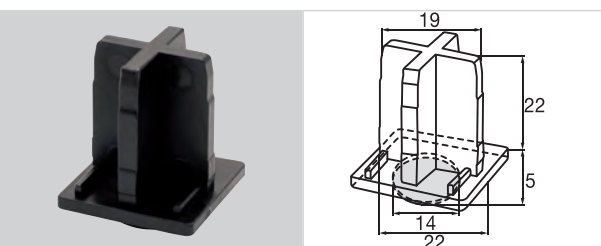

	Ø mm					pcs.	Code	EAN-Code 4001073 ...
	17	19x19				100	15 9082 01	...027044

Basis zum Einstecken in Rund-/Vierkantrohre

Base for insertion into round/square tubes

Base à enficher dans tubes ronds/carrés

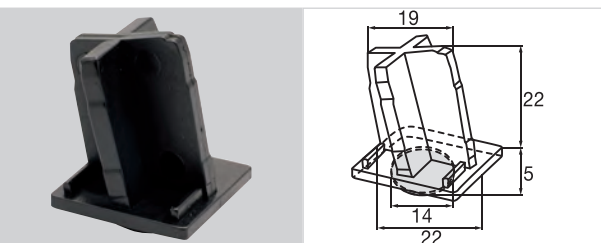





	Ø mm					pcs.	Code	EAN-Code 4001073 ...
	17	19x19				100	15 9081 01	...027037

Basis „QUATTRO“ zum Einstecken in Vierkantrohre

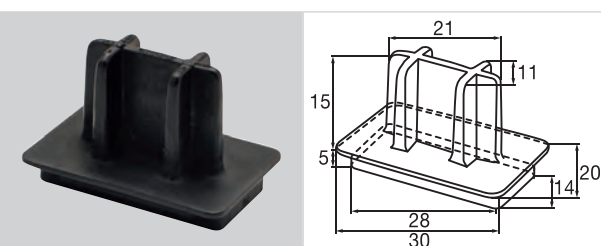
Base „QUATTRO“ for insertion into square tubes

Base „QUATTRO“ à enficher dans tubes carrés



	Ø mm					pcs.	Code	EAN-Code 4001073 ...
	31x17	19x29				100	15 9491 01	...492729
	31x17	19x29				100	15 9487 01	...492644

Basis mit Hülse zum Einstecken in Ovalrohre

Base with sleeve for putting into oval tubes



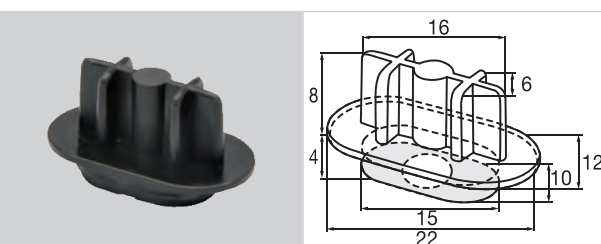



Base avec douille à enficher dans tubes ovale

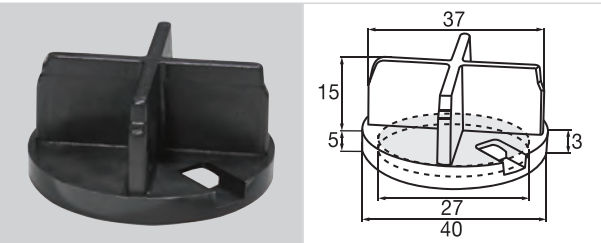

	Ø mm					pcs.	Code	EAN-Code 4001073 ...
	17x12	22x12				100	15 9494 01	...326277





Basis zum Einstecken in Rundrohre  
 Base for insertion into round tubes  
 Base à enficher dans tubes ronds

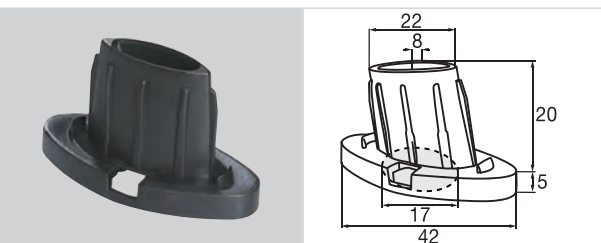

	Ø mm				pcs.	Code	EAN-Code 4001073 ...
	30	40/37	Hyper		100	15 9096 01*	...329780
	30	40/37	Ultrasoft		100	15 9097 01*	...197839
	30	40/37	Hyper		100	15 9098 01*	...197846
	30	40/37	Ultrasoft		100	15 9099 01*	...197853

Basis mit Hülse zum Einstecken in gerade u. schräg stehende Rohre  
 Base with sleeve for putting into straight and diagonal tubes  
 Base avec douille à enficher dans tubes droits et inclinés





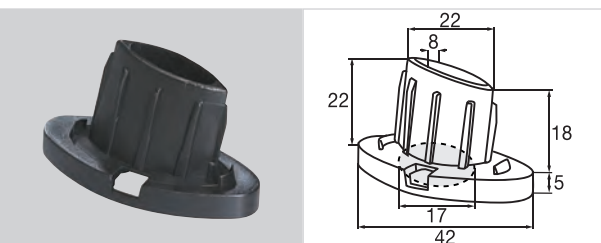

	Ø mm			pcs.	Code	EAN-Code 4001073 ...
	20	22x8	Hyper	100	15 9326 01*	...595482
	20	22x8	Ultrasoft	100	16 9301 01*	...038170

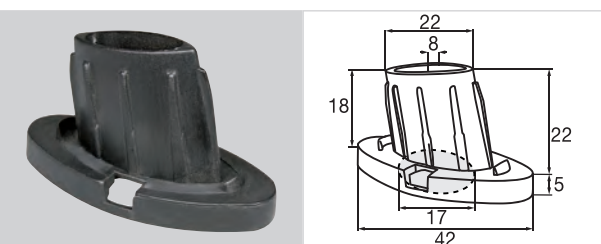





	Ø mm			pcs.	Code	EAN-Code 4001073 ...
	20	22x8	Hyper	100	15 9327 01*	...595499

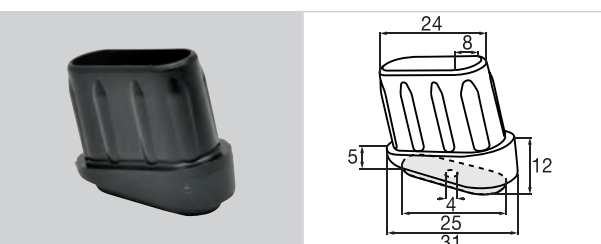

	Ø mm			pcs.	Code	EAN-Code 4001073 ...
	20	22x8	Hyper	100	16 9302 01*	...221930
	20	22x8		100	15 9306 01	...595192

Kundenspezifischer Artikel hergestellt für **interstuhl**  
 This article is produced exclusively for  
 Article spécifique fabriqué pour



	Ø mm		Degree°	pcs.	Code	EAN-Code 4001073 ...
	30x15	36x12	12°	100	15 9325 01	...015539
	30x15	26x12	32°	100	15 9323 01	...215250

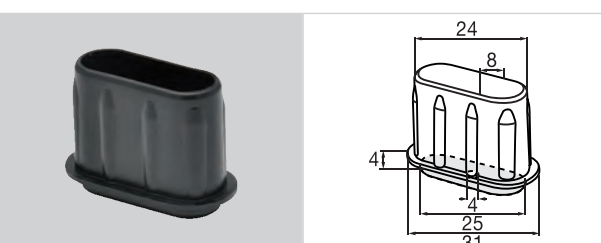

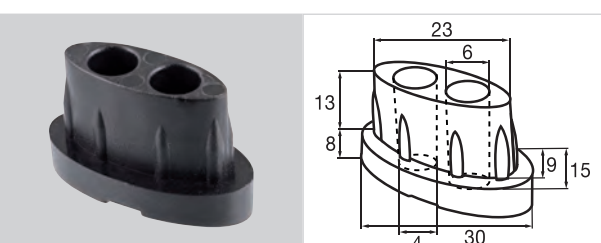

	Ø mm			pcs.	Code	EAN-Code 4001073 ...
	30x15	26x12		100	15 9312 01	...014242

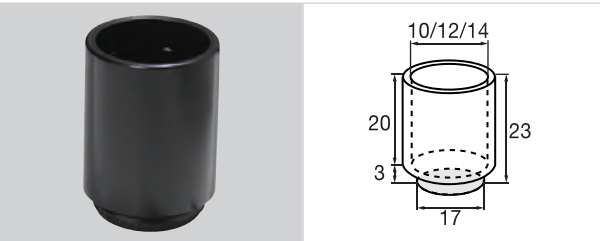

	Ø mm			pcs.	Code	EAN-Code 4001073 ...
	23x14	30x15		100	16 9330 01	...200348

Basis-Kappe zum Aufstecken für Stahlrohrmöbel  
 Base cap for plugging onto steel tube furniture  
 Base capuchon à enficher pour meubles en acier



	Ø mm					pcs.	Code	EAN-Code 4001073 ...
■	17	17/10				100	16 9162 01	...331677
■	17	17/12				100	15 9161 01	...307283
■	17	17/14				100	15 9160 01	...307276

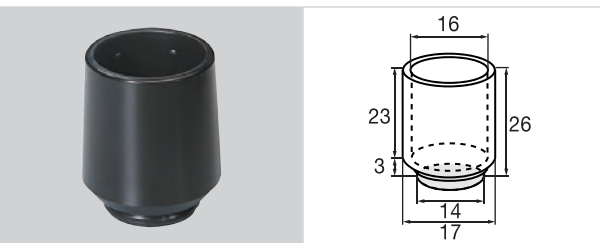

	Ø mm					pcs.	Code	EAN-Code 4001073 ...
■	17	17/16				100	15 9162 01	...307375

Basis gebogen zum Aufstecken an Ovalrohre  
 Curved base for plugging onto oval tubes  
 Base cambrée à enficher aux tubes ovales

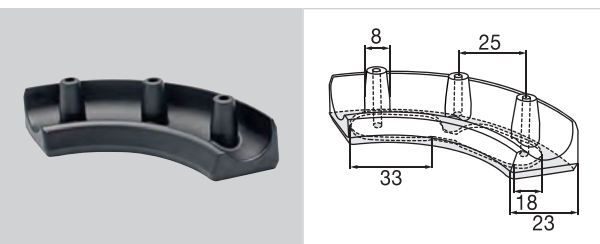

	Ø mm					pcs.	Code	EAN-Code 4001073 ...
■	35x20					100	15 9426 01	...319170

Kundenspezifischer Artikel hergestellt für **VANERUM**  
 This article is produced exclusively for **an i3-Solutions company**  
 Article spécifique fabriqué pour

Basis zum Einstecken in z.B. Holz-/Stahlrohrmöbel  
 Base for insertion into e.g. wooden-/steel tube furniture  
 Base à enficher par ex. dans meubles en bois/acier

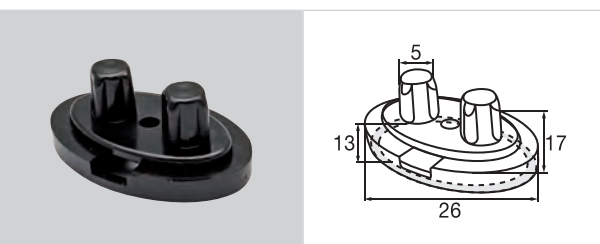

	Ø mm					pcs.	Code	EAN-Code 4001073 ...
■	23x14					100	15 9429 01	...314397
■	23x14					100	15 9435 01	...316780
■	23x14					100	15 9434 01	...315868

Kundenspezifischer Artikel hergestellt für **arper**  
 This article is produced exclusively for  
 Article spécifique fabriqué pour









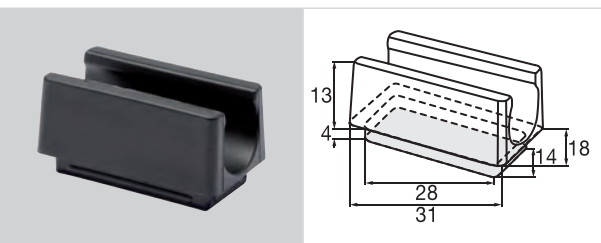

Basis „STRING“ zum Einpressen auf z.B. Rundrohre

Base „STRING“ to press onto e.g. round tubes

Base „STRING“ à apposer par ex. aux tubes ronds











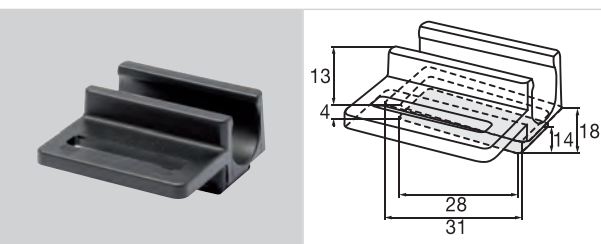

	Ø mm					pcs.	Code	EAN-Code 4001073 ...
	31x17	10				100	15 9164 01	...326574
	31x17	11				100	15 9170 01	...322682
	31x17	12				100	15 9174 01	...322880
	31x17	14				100	15 9182 01	...325072
	31x17	11				100	15 9187 01	...014938
	31x17	12				100	15 9180 01	...325775
	31x17	14				100	15 9198 01	...325669

Basis „CONNECT“ zum Einpressen auf z.B. Rundrohre







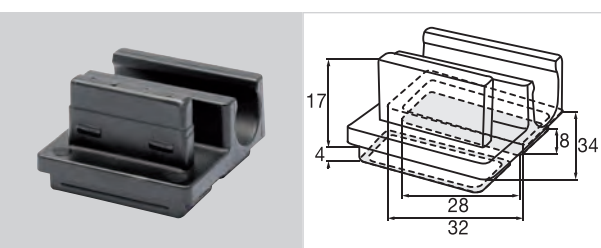

Base „CONNECT“ to press onto e.g. round tubes

Base „CONNECT“ à apposer par ex. aux tubes ronds



	Ø mm					pcs.	Code	EAN-Code 4001073 ...
	31x17	10				100	15 9158 01	...326789
	31x17	11				100	15 9173 01	...322590
	31x17	12				100	15 9177 01	...322972
	31x17	14				100	15 9185 01	...015119
	31x17	11				100	15 9188 01	...325164
	31x17	12				100	15 9192 01	...325485
	31x17	14				100	15 9166 01	...325690



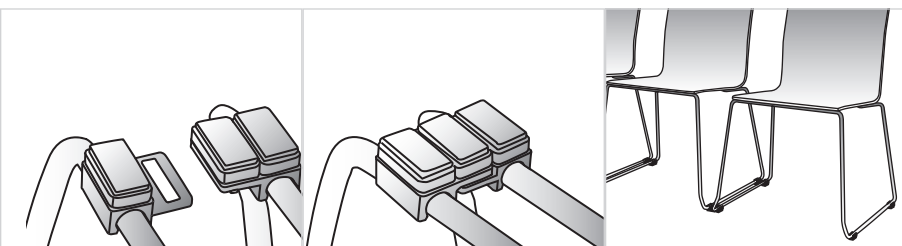

	Ø mm					pcs.	Code	EAN-Code 4001073 ...
	31x17	10				100	15 9159 01	...326772
	31x17	11				100	15 9172 01	...322668
	31x17	12				100	15 9176 01	...322965
	31x17	14				100	15 9186 01	...015058
	31x17	11				100	15 9189 01	...325171
	31x17	12				100	15 9193 01	...325492
	31x17	14				100	15 9150 01	...035162



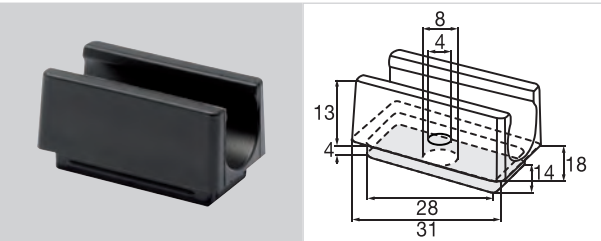

Basis „STRING“ zum Einpressen/Anschrauben an z.B. Rundrohre  
 Base „STRING“ to press/fasten onto e.g. round tubes  
 Base „STRING“ à apposer/visser par ex. aux tubes ronds



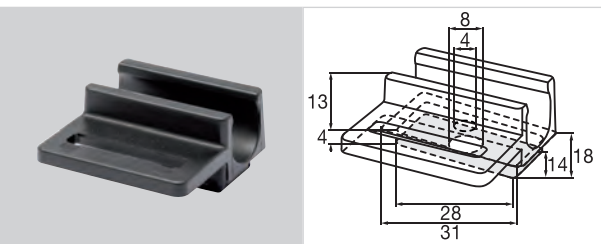

	Ø mm					pcs.	Code	EAN-Code 4001073 ...
■	31x17	10				100	15 9163 01	...326581
■	31x17	11				100	15 9171 01	...322675
■	31x17	12				100	15 9175 01	...322897
■	31x17	14				100	15 9181 01	...325065
■	31x17	11				100	15 8976 01	...053357
■	31x17	12				100	15 9194 01	...325560
■	31x17	14				100	15 9197 01	...325591

Basis „CONNECT“ zum Einpressen/Anschrauben an z.B. Rundrohre  
 Base „CONNECT“ to press/fasten onto e.g. round tubes  
 Base „CONNECT“ à apposer/visser par ex. aux tubes ronds

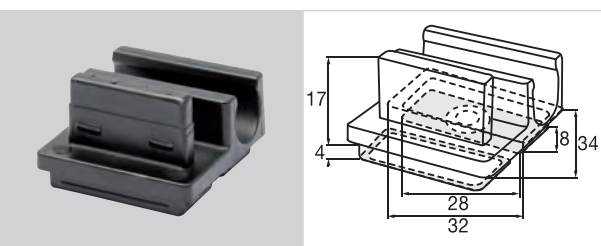

	Ø mm					pcs.	Code	EAN-Code 4001073 ...
■	31x17	10				100	15 9157 01	...326796
■	31x17	11				100	15 9169 01	...323993
■	31x17	12				100	15 9178 01	...323177
■	31x17	14				100	15 9183 01	...325089
■	31x17	11				100	15 9199 01	...325676
■	31x17	12				100	15 9195 01	...325577
■	31x17	14				100	15 9151 01	...417937



	Ø mm					pcs.	Code	EAN-Code 4001073 ...
■	31x17	10				100	15 9156 01	...326864
■	31x17	11				100	15 9168 01	...323986
■	31x17	12				100	15 9179 01	...323184
■	31x17	14				100	15 9184 01	...015133
■	31x17	11				100	15 9191 01	...325478
■	31x17	12				100	15 9196 01	...325584
■	31x17	14				100	15 9167 01	...325683

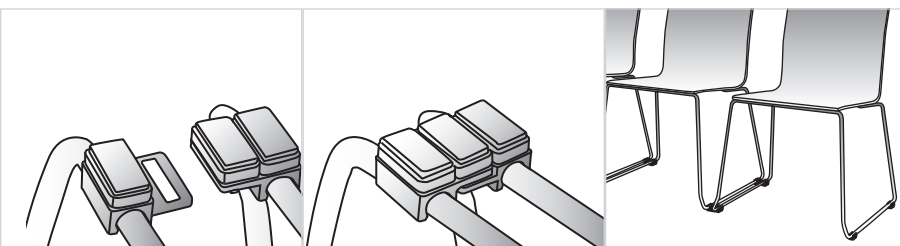

Basis „UNO” SUPER zum Einpressen auf Vierkantrohre  
 Base „UNO” SUPER to press onto square tubes  
 Base „UNO” SUPER à apposer aux tubes carrés

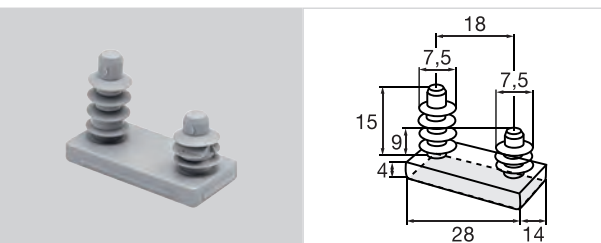



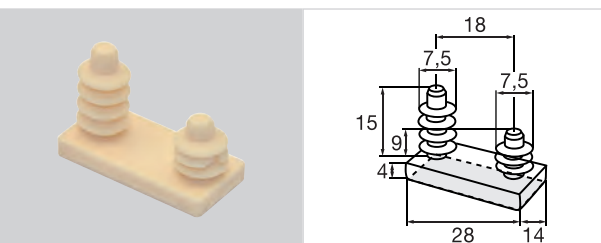

	Ø mm		18		pcs.	Code	EAN-Code 4001073 ...
	31x17	28x14			100	15 9454 01	...307467

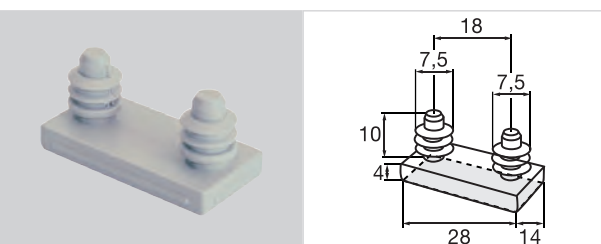

	Ø mm		18		pcs.	Code	EAN-Code 4001073 ...
	31x17	28x14			100	15 9443 01	...321968



	Ø mm		18		pcs.	Code	EAN-Code 4001073 ...
	31x17	28x14			100	15 8008 01	...490541
	31x17	28x14			100	15 8001 01	...493801

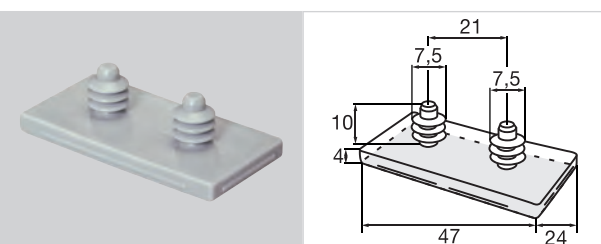

	Ø mm				pcs.	Code	EAN-Code 4001073 ...
	50x27	47x24			100	15 9479 01	...322071

Basis „UNO“ HYPER zum Einpressen auf Vierkantrohre  
 Base „UNO“ HYPER to press onto square tubes  
 Base „UNO“ HYPER à apposer aux tubes carrés

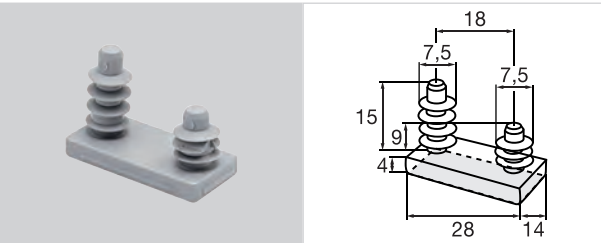

	Ø mm					pcs.	Code	EAN-Code 4001073 ...
	31x17	28x14				100	15 7954 01	...307962

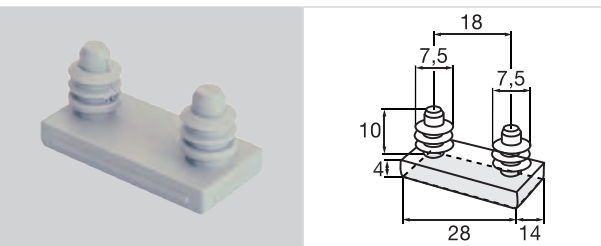

	Ø mm					pcs.	Code	EAN-Code 4001073 ...
	31x17	28x14				100	15 7955 01	...312072

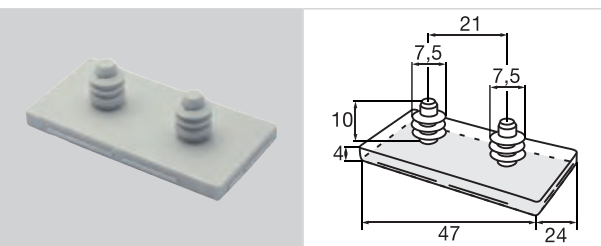

	Ø mm					pcs.	Code	EAN-Code 4001073 ...
	50x27	47x24				100	15 7953 01	...307979

Basis „UNO“ STOPP zum Einpressen auf Vierkantrohre  
 Base „UNO“ STOPP to press onto square tubes  
 Base „UNO“ STOPP à apposer aux tubes carrés

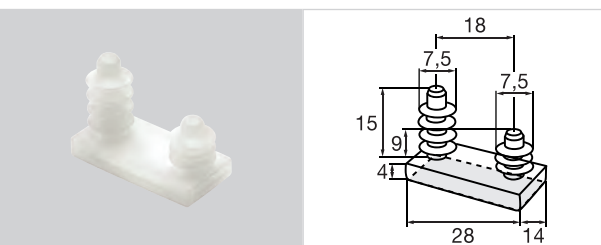

	Ø mm					pcs.	Code	EAN-Code 4001073 ...
	31x17	28x14				100	15 9556 01	...307566

Basis „UNO“ BLACK zum Einpressen auf Vierkantrohre  
 Base „UNO“ BLACK to press onto square tubes  
 Base „UNO“ BLACK à apposer aux tubes carrés

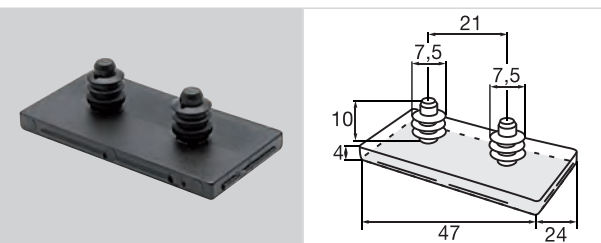

	Ø mm					pcs.	Code	EAN-Code 4001073 ...
	50x27	47x24				100	15 9453 01	...307399

Basis zum Einpressen in z.B. Rundrohre  
 Base to press into e.g. round tubes  
 Base à enfoncer par ex. dans tubes rondes

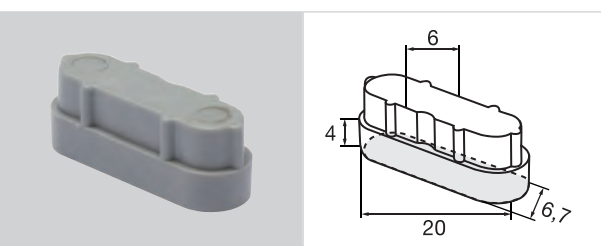

	Ø mm					pcs.	Code	EAN-Code 4001073 ...
RAL7045	20x6,7					100	16 9215 01	...328783

Gleiter zum Einpressen in z.B. Vierkantrohre  
 Furniture glider to press into e.g. square tubes  
 Patin de meuble à enfoncer par ex. dans tubes carrés

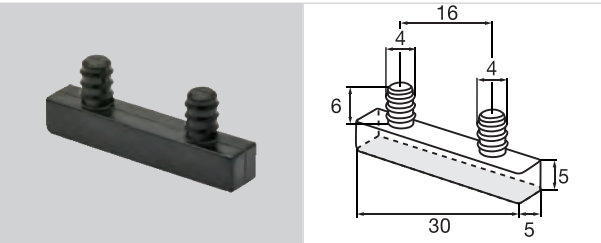

						pcs.	Code	EAN-Code 4001073 ...
	30x6					100	16 8000 01	...327588
	30x6					100	16 8001 01	...328479
	30x6					100	16 8004 01	...329094

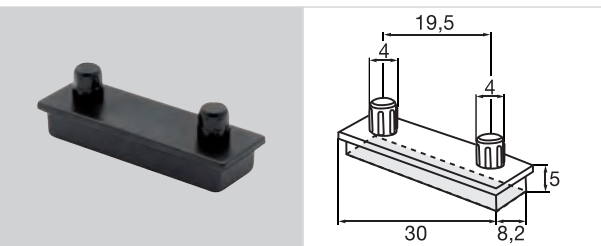

						pcs.	Code	EAN-Code 4001073 ...
	30x10					100	16 8013 01	...026290

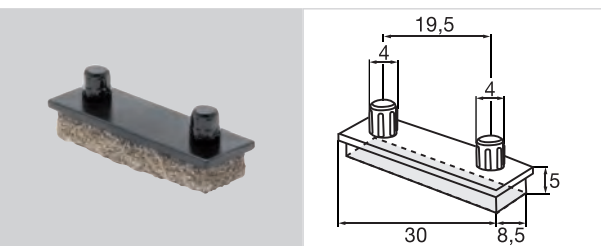

						pcs.	Code	EAN-Code 4001073 ...
	30x10					100	16 8014 01	...214147

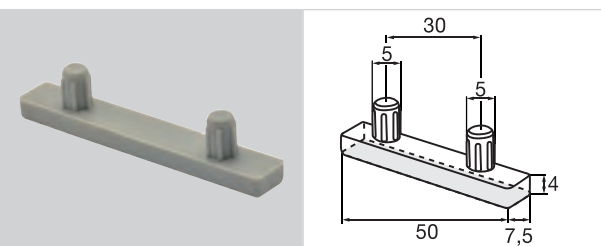

						pcs.	Code	EAN-Code 4001073 ...
	50x7,5					100	16 8002 01	...493818
	50x7,5					100	16 8022 01	...218428

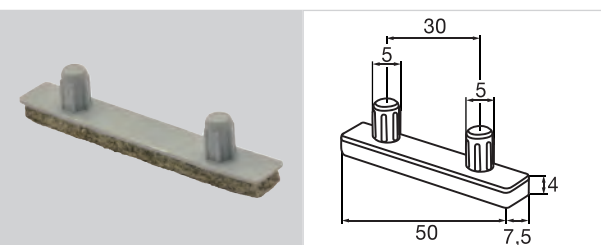

						pcs.	Code	EAN-Code 4001073 ...
	50x7,5					100	16 8003 01	...493832
	50x7,5					100	16 8023 01	...415926

Basis „SLIM“ zum Nageln in z.B. Holzmöbel  
 Base „SLIM“ to nail on e.g. wooden furniture  
 Base „SLIM“ pour clouer dans des meubles en bois

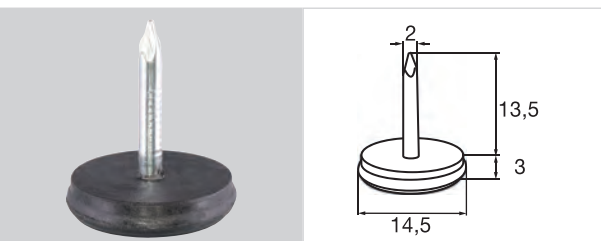

	Ø mm					pcs.	Code	EAN-Code 4001073 ...
	20					100	15 4193 01	...005196

Gleiter zum Anschrauben an z. B. Kufenstühle, natur  
 Glider for screwing on e.g. skid-base chairs, nature  
 Patin à visser par ex. chaises à patins, nature

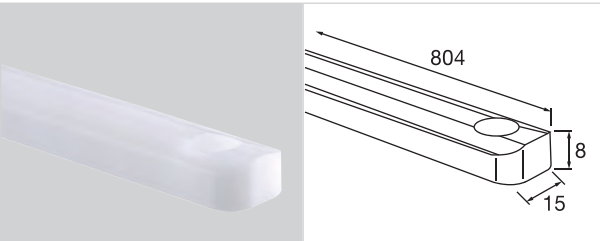

	Ø mm					pcs.	Code	EAN-Code 4001073 ...
	804x15					100	16 5010 01	...155860

Gleiter zum Anschrauben an z. B. Kufenstühle, schwarz  
 Glider for screwing on e.g. skid-base chairs, black  
 Patin à visser par ex. chaises à patins, noir

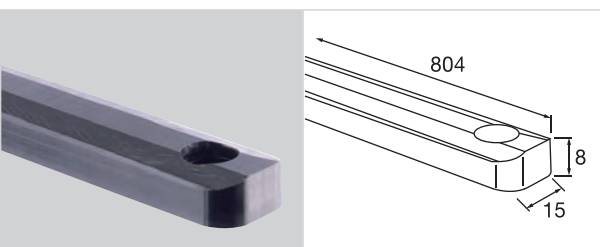

	Ø mm					pcs.	Code	EAN-Code 4001073 ...
	804x15					100	16 5011 01	...452778



Gleiter ULTRASOFT selbstklebend für z. B. Schaukelstühle

Glider ULTRASOFT self-adhesive for e.g. rocking chairs

Patin à visser ULTRASOFT autocollant pour par exemple chaises à bascule

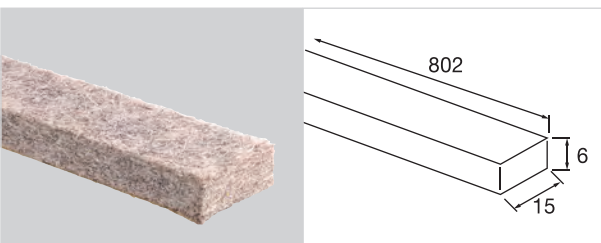

Ø mm						pcs.	Code	EAN-Code 4001073 ...
802x15						100	16 5013 01	...456444

Gleiter SYNO selbstklebend für z. B. Schaukelstühle

Glider SYNO self-adhesive for e.g. rocking chairs

Patin à visser SYNO autocollant pour par exemple chaises à bascule

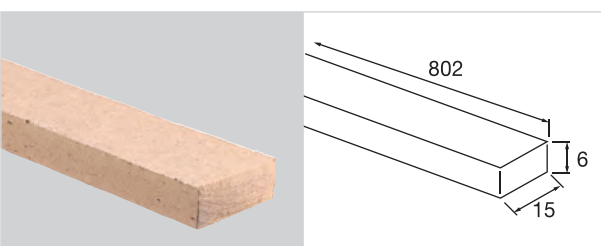

Ø mm						pcs.	Code	EAN-Code 4001073 ...
802x15						100	16 5014 01	...100624





**QUICKCLICK SLIM**

DEUTSCH ENGLISH ITALIANO

**FILIGRANO**

DEUTSCH ENGLISH ITALIANO

**QUICKCLICK SMART**

DEUTSCH ENGLISH ITALIANO

# high

**OVAL BASE**

DEUTSCH ENGLISH ITALIANO

**QUICKCLICK DUO**

DEUTSCH ENGLISH ITALIANO

**JOINT GLIDER**

DEUTSCH ENGLISH ITALIANO

## QUICKCLICK PIEDI



## QUICKCLICK LOUNGE



## TANDEM UNO

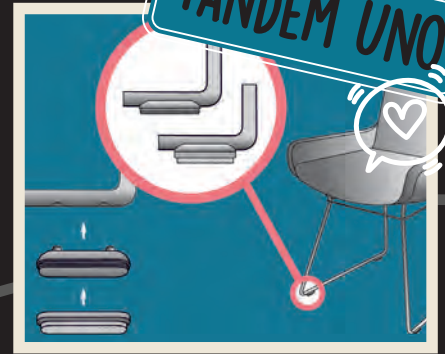

# tutorial

## T-CONNECT



## JUSTUS SLIM

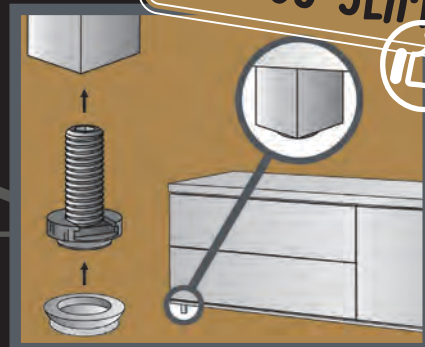



# QuickClick® ULTRASOFT



Ein-/Aufsatz ULTRASOFT zum Ein-/Aufdrücken in/auf jede passende Basis - besonders geräuscharm

ULTRASOFT insert/cap to click into/onto every suitable base - particularly low noise level

Insert/Embout ULTRASOFT à enfoncer dans/sur chaque base appropriée - particulièrement silencieux

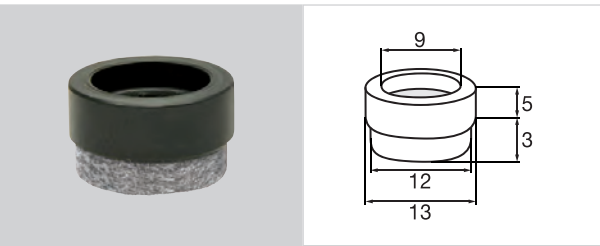

 Ø mm					pcs.	Code	EAN-Code 4001073 ...
13					100	15 8136 01	...015546
13					100	15 8139 01	...057348



 Ø mm					pcs.	Code	EAN-Code 4001073 ...
17					100	15 8147 01	...051452
17					100	15 8149 01	...051537
17					100	15 8148 01	...051629
17					100	15 8164 01	...397918

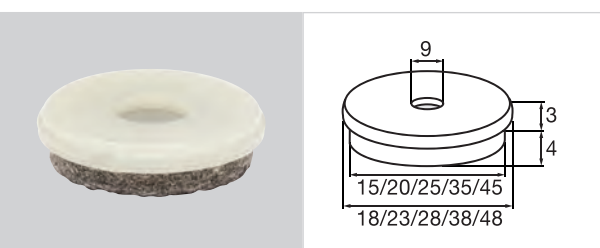

 Ø mm					pcs.	Code	EAN-Code 4001073 ...
20					100	15 8007 01	...491104
25					100	15 8299 01	...053210
20					100	15 8272 01	...050530
25					100	15 8273 01	...050622
30					100	15 8274 01	...050653
40					100	15 8275 01	...050707
50					100	15 8276 01	...050509



 Ø mm					pcs.	Code	EAN-Code 4001073 ...
17x12					100	15 8983 01	...308983
17x12					100	15 8988 01	...315479



 Ø mm					pcs.	Code	EAN-Code 4001073 ...
20x25					100	15 8997 01	...053326



Ein-/Aufsatz ULTRASOFT zum Ein-/Aufdrücken in/auf jede passende Basis - besonders geräuscharm

ULTRASOFT insert/cap to click into/onto every suitable base - particularly low noise level

Insert/Embout ULTRASOFT à enfoncer dans/sur chaque base appropriée - particulièrement silencieux

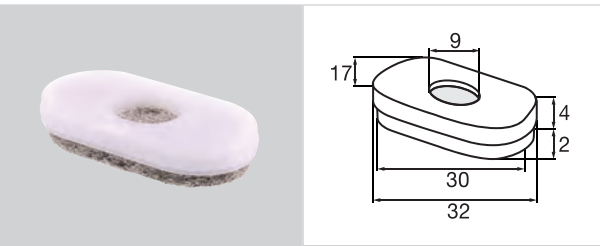

 Ø mm					pcs.	Code	EAN-Code 4001073 ...
35x20					100	15 9514 01	...308068



 Ø mm					pcs.	Code	EAN-Code 4001073 ...
30x15					100	15 9422 01	...015454



 Ø mm					pcs.	Code	EAN-Code 4001073 ...
39x12					100	15 8989 01	...315776
39x12					100	15 8992 01	...324464
39x12					100	15 8990 01	...317183

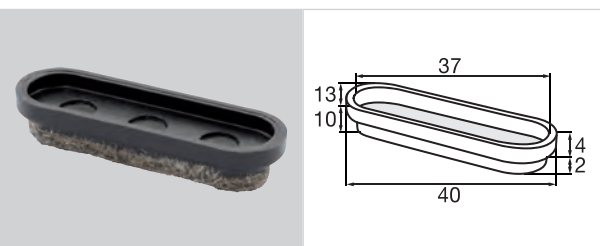

 Ø mm					pcs.	Code	EAN-Code 4001073 ...
39x12					100	16 8901 01	...354058
39x12					100	16 8911 01	...551846

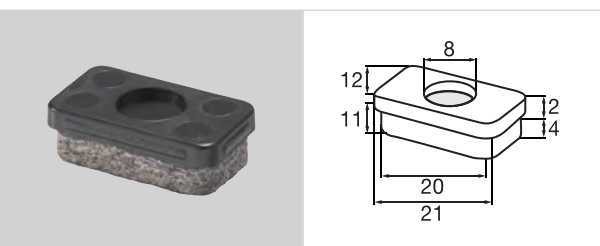

 Ø mm					pcs.	Code	EAN-Code 4001073 ...
23x15					100	15 8974 01	...306361



 Ø mm					pcs.	Code	EAN-Code 4001073 ...
22,7x13,8					100	15 9515 01	...314373

Kundenspezifischer Artikel hergestellt für  
This article is produced exclusively for  
Article spécifique, fabriqué pour

arper

# QuickClick® ULTRASOFT



Aufsatz ULTRASOFT zum Aufdrücken auf jede passende Basis -  
besonders geräuscharm

ULTRASOFT cap to click onto every suitable base - particularly low  
noise level

Embout ULTRASOFT à enfoncer sur toute base appropriée -  
particulièrement silencieux

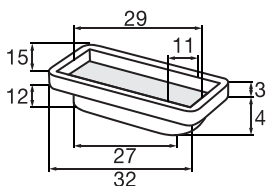
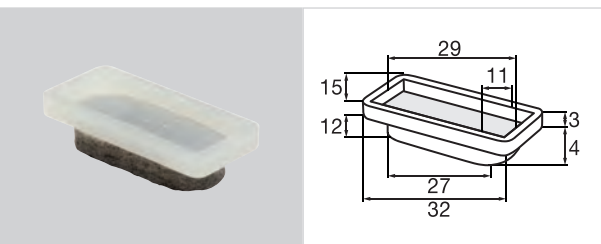

 Ø mm					pcs.	Code	EAN-Code 4001073 ...
32x15					100	15 9546 01	...309270

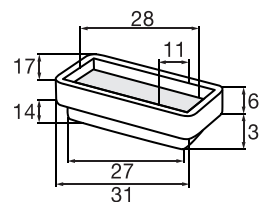
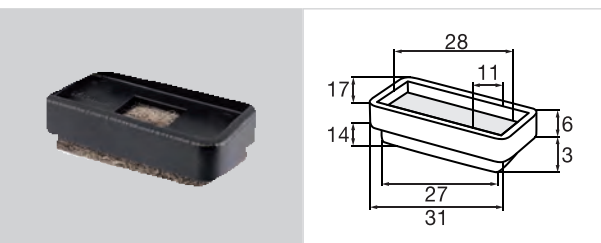

 Ø mm					pcs.	Code	EAN-Code 4001073 ...
31x17					100	15 9549 01	...309485
31x17					100	15 9545 01	...309461
31x17					100	15 9573 01	...326291

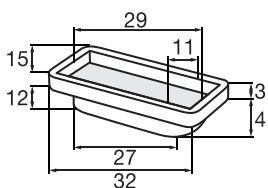
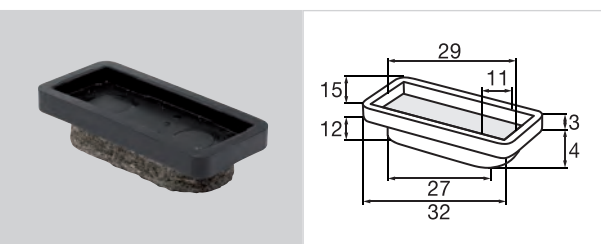

 Ø mm					pcs.	Code	EAN-Code 4001073 ...
32x15					100	15 9506 01	...300864

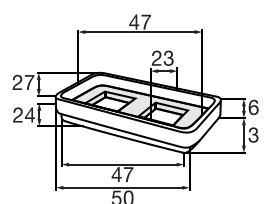
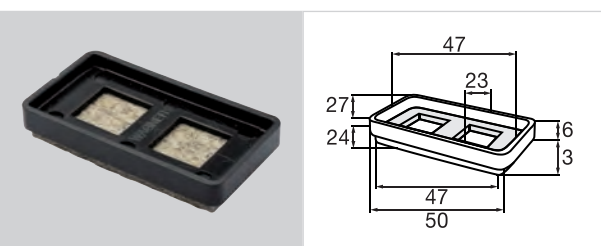

 Ø mm					pcs.	Code	EAN-Code 4001073 ...
50x27					100	15 9548 01	...309478



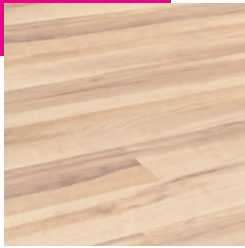

Aufsatz ULTRASOFT zum Aufdrücken auf Basis „LOUNGE“ und „EASY LOUNGE“ - besonders geräuscharm

ULTRASOFT insert to click onto base „LOUNGE“ and „EASY LOUNGE“ - particularly low noise level

Embout ULTRASOFT à enfoncer sur base „LOUNGE“ et „EASY LOUNGE“ - particulièrement silencieux







	Ø mm					pcs.	Code	EAN-Code 4001073 ...
	40					100	16 0409 01	...053722

NEW ULTRASOFT zum Eindrücken in jede passende Basis - besonders geräuscharm

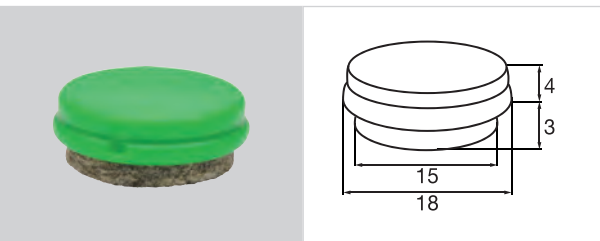
NEW ULTRASOFT insert to click in every suitable base - particularly low noise level

NEW ULTRASOFT à enfoncer dans toute base appropriée - particulièrement silencieux



	Ø mm					pcs.	Code	EAN-Code 4001073 ...
	20					100	15 8062 01	...053456
	25					100	15 8236 01	...053500
	30					100	15 8237 01	...332162

# QuickClick® ULTRASOFT





Aufsatz ULTRASOFT „SLIM“ zum Aufdrücken auf jede passende Basis - besonders geräuscharm

ULTRASOFT „SLIM“ cap to click onto every suitable base - particularly low noise level

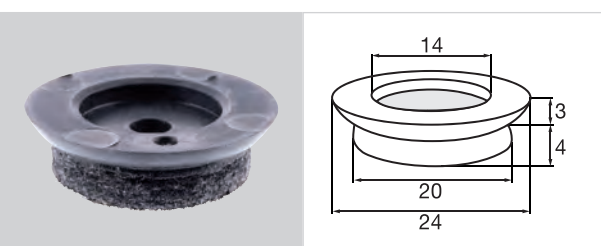
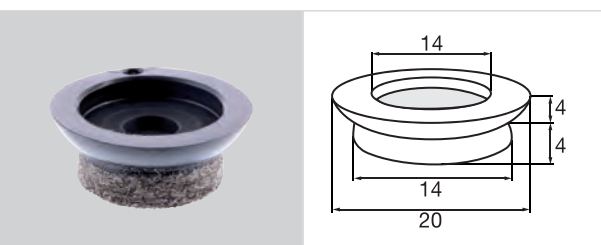
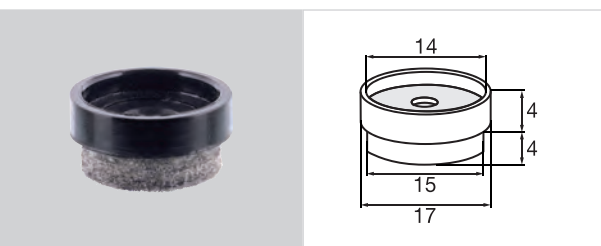
Embout ULTRASOFT „SLIM“ à enfoncer sur toute base appropriée - particulièrement silencieux



 Ø mm					pcs.	Code	EAN-Code 4001073 ...
17					100	15 8158 01	...050547
17					100	16 8202 01	...455267
17					100	15 8150 01	...050554
17					100	15 8155 01	...050608
17					100	15 8156 01	...050523

 Ø mm					pcs.	Code	EAN-Code 4001073 ...
20					100	15 8290 01	...052510
20					100	16 8200 01	...057249

 Ø mm					pcs.	Code	EAN-Code 4001073 ...
25					100	15 8283 01	...050929
25					100	16 8201 01	...057256





Aufsatz ULTRASOFT „SLIM ECO FRIENDLY“ zum Aufdrücken auf jede passende Basis - besonders geräuscharm

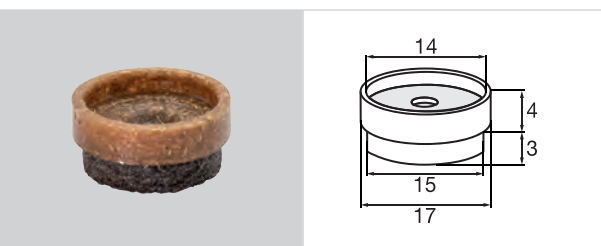

ULTRASOFT „SLIM ECO FRIENDLY“ cap to click onto every suitable base - particularly low noise level

Embout ULTRASOFT „SLIM ECO FRIENDLY“ à enfoncer sur toute base appropriée - particulièrement silencieux



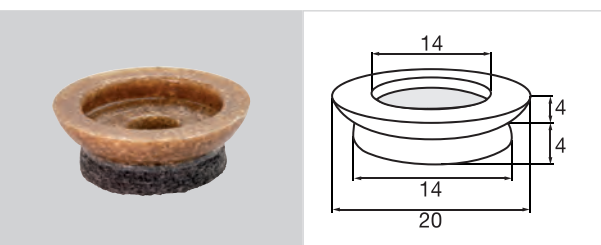

	Ø mm					pcs.	Code	EAN-Code 4001073 ...
	17					100	15 8382 01	...499513
	17					100	15 8379 01	...104950

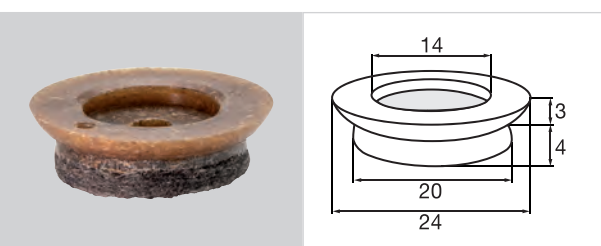

	Ø mm					pcs.	Code	EAN-Code 4001073 ...
	20					100	15 8383 01	...103830
	20					100	15 8380 01	...159493









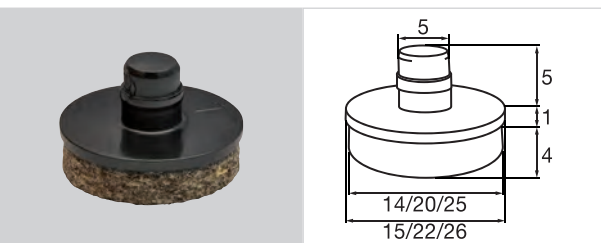

	Ø mm					pcs.	Code	EAN-Code 4001073 ...
	25					100	15 8384 01	...697858
	25					100	15 8381 01	...157994

# QuickClick® ULTRASOFT



Aufsatz SMART ULTRASOFT zum Eindrücken in Basis „SMART“  
 SMART ULTRASOFT cap to click into base „SMART“  
 Embout SMART ULTRASOFT à enfoncer dans base „SMART“



 	Ø mm					pcs.	Code	EAN-Code 4001073 ...
	15					100	16 0430 01	...054644
	20					100	16 0444 01	...494112
	26					100	16 0936 01	...155976
	15					100	16 0470 01	...494525
	20					100	16 0471 01	...494532

Aufsatz SMART ULTRASOFT zum Eindrücken in Basis  
 SMART ULTRASOFT cap to click into base  
 Embout SMART ULTRASOFT à enfoncer dans base

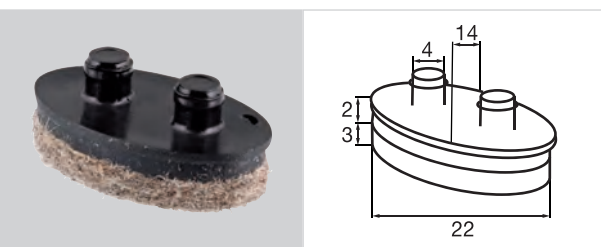

 	Ø mm					pcs.	Code	EAN-Code 4001073 ...
	23x14					100	16 8046 01	...599787



Ein-/Aufsatz SOFT zum Ein-/Aufdrücken in/auf jede passende Basis  
SOFT insert/cap to click into/onto every suitable base  
Insert/Embout SOFT à enfoncer dans/sur chaque base appropriée

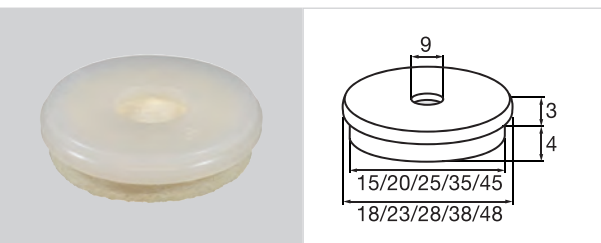

 Ø mm	pcs.	Code	EAN-Code 4001073 ...
20	100	15 8254 01	...046632
25	100	15 8255 01	...046625
30	100	15 8256 01	...046618
40	100	15 8264 01	...045949
50	100	15 8257 01	...047110

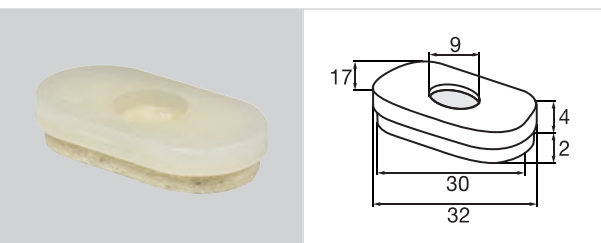

 Ø mm	pcs.	Code	EAN-Code 4001073 ...
35x20	100	15 9504 01	...299373

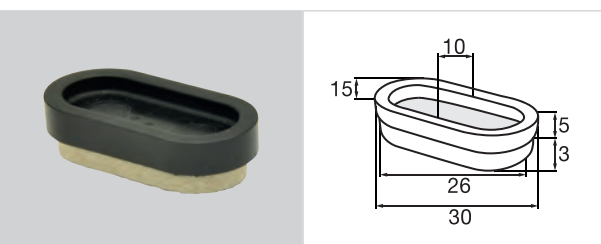

 Ø mm	pcs.	Code	EAN-Code 4001073 ...
30x15	100	15 9499 01	...000818

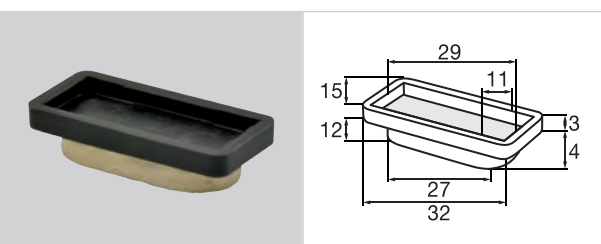



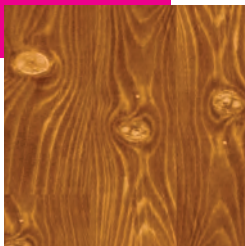

 Ø mm	pcs.	Code	EAN-Code 4001073 ...
32x15	100	15 8576 01	...324778

## QuickClick<sup>®</sup> SOFT

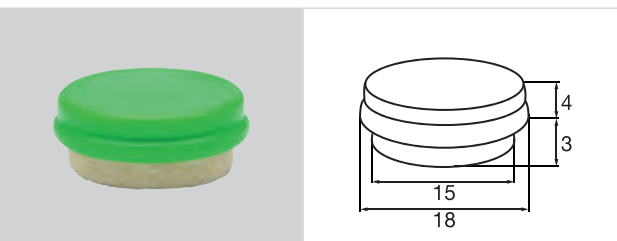

Einsatz NEW SOFT zum Eindrücken in jede passende Basis  
 NEW SOFT insert to click into every suitable base  
 Insert NEW SOFT à enfoncer dans chaque base appropriée







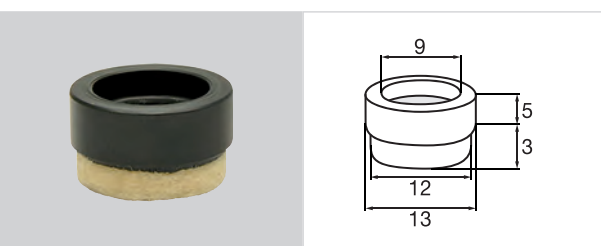

	Ø mm					pcs.	Code	EAN-Code 4001073 ...
	20					100	15 8296 01	...068351
	25					100	15 8126 01	...053524

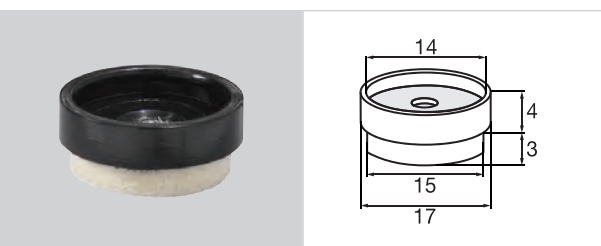
Aufsatz SOFT zum Aufdrücken in jede passende Basis  
 SOFT cap to click into every suitable base  
 Embout SOFT à enfoncer dans chaque base appropriée









	Ø mm					pcs.	Code	EAN-Code 4001073 ...
	13					100	15 8124 01	...014143

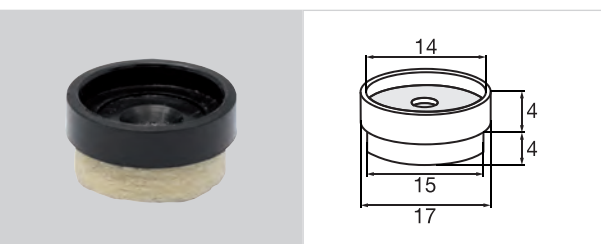

	Ø mm					pcs.	Code	EAN-Code 4001073 ...
	17					100	15 8108 01	...298178
	17					100	15 8109 01	...298185
	17					100	15 8110 01	...298192
	17					100	15 8107 01	...298161

Aufsatz SOFT „SLIM“ zum Aufdrücken auf jede passende Basis  
 SOFT „SLIM“ cap to click onto every suitable base  
 Embout SOFT „SLIM“ à enfoncer sur chaque base appropriée



	Ø mm					pcs.	Code	EAN-Code 4001073 ...
	17					100	15 8118 01	...307191
	17					100	15 8119 01	...307269
	17					100	15 8120 01	...307290
	17					100	15 8157 01	...307184



Ein-/Aufsatz NATURAL zum Ein-/Aufdrücken in/auf jede passende Basis  
 NATURAL insert/cap to click into/onto every suitable base  
 Insert/Embout NATURAL à enfoncer dans/sur chaque base appropriée

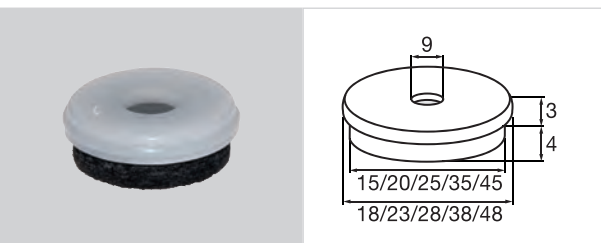

 Ø mm	pcs.	Code	EAN-Code 4001073 ...
20	100	15 8023 01	...488333
25	100	15 8028 01	...488739
30	100	15 8033 01	...489132
40	100	15 8265 01	...045956
50	100	15 8044 01	...047103



 Ø mm	pcs.	Code	EAN-Code 4001073 ...
17x12	100	15 8982 01	...308990
17x12	100	15 8986 01	...308969

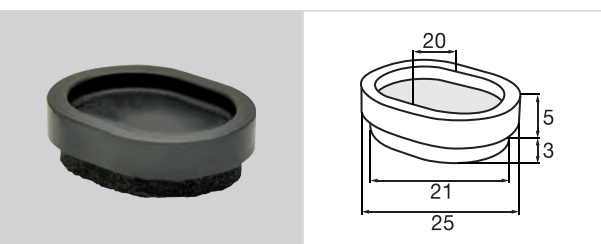

 Ø mm	pcs.	Code	EAN-Code 4001073 ...
20x25	100	15 8993 01	...053104
20x25	100	15 8994 01	...053203

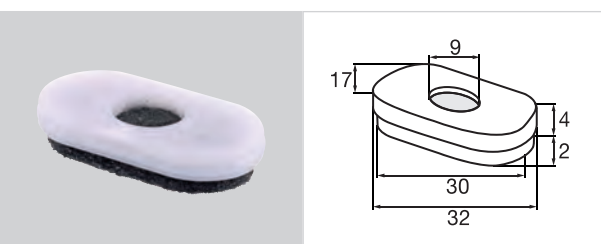

 Ø mm	pcs.	Code	EAN-Code 4001073 ...
35x20	100	15 9503 01	...299366







 Ø mm	pcs.	Code	EAN-Code 4001073 ...
30x15	100	15 9418 01	...015935

# QuickClick<sup>®</sup> NATURAL

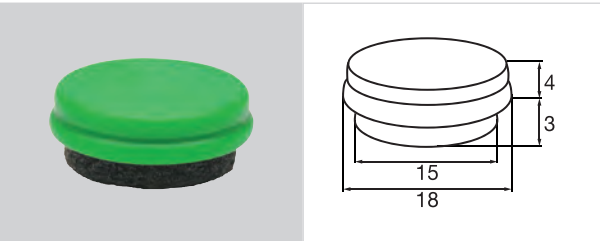

Einsatz NEW NATURAL zum Eindrücken in jede passende Basis  
 NEW NATURAL insert to click into every suitable base  
 Insert NEW NATURAL à enfoncer dans chaque base appropriée



 Ø mm					pcs.	Code	EAN-Code 4001073 ...
	20				100	15 8057 01	...053449
	25				100	15 8014 01	...053517
	30				100	15 8410 01	...220438

Aufsatz NATURAL zum Aufdrücken auf Basis „LOUNGE“ und „EASY LOUNGE“ - besonders geräuscharm  
 NATURAL insert to click onto base „LOUNGE“ and „EASY LOUNGE“ - particularly low noise level  
 Embout NATURAL à enfoncer sur base „LOUNGE“ et „EASY LOUNGE“ - particulièrement silencieux







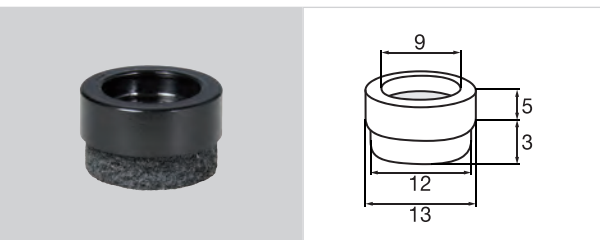

 Ø mm					pcs.	Code	EAN-Code 4001073 ...
	40				100	16 0408 01	...053715

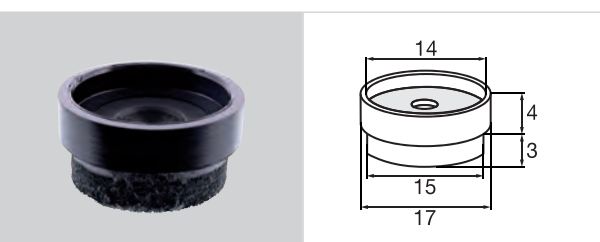
Aufsatz NATURAL zum Aufdrücken in jede passende Basis  
 NATURAL cap to click into every suitable base  
 Embout NATURAL à enfoncer dans chaque base appropriée



 Ø mm					pcs.	Code	EAN-Code 4001073 ...
	13				100	16 8129 01	...024586









 Ø mm					pcs.	Code	EAN-Code 4001073 ...
	17				100	15 8104 01	...298079
	17				100	15 8105 01	...298086
	17				100	15 8106 01	...298093
	17				100	15 8103 01	...298062

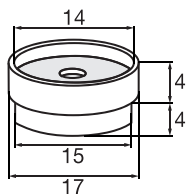



Aufsatz NATURAL „SLIM“ zum Aufdrücken auf jede passende Basis  
 NATURAL „SLIM“ cap to click onto every suitable base  
 Embout NATURAL „SLIM“ à enfoncer sur chaque base appropriée



	Ø mm					pcs.	Code	EAN-Code 4001073 ...
	17					100	15 8114 01	...307092
	17					100	15 8115 01	...307160
	17					100	15 8116 01	...307177
	17					100	15 8113 01	...307085
	20					100	16 8114 01	...222005

# QuickClick<sup>®</sup> SYNO<sup>®</sup>

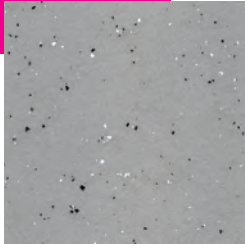

Ein-/Aufsatz SYNO zum Ein-/Aufdrücken in/auf jede passende Basis

SYNO insert/cap to click into/onto every suitable base

Insert/Embout SYNO à enfoncer dans/sur chaque base appropriée

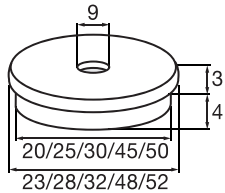
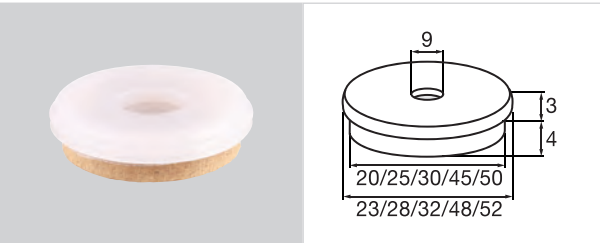

 Ø mm					pcs.	Code	EAN-Code 4001073 ...
20					100	15 8364 01	...312850
25					100	15 8365 01	...114842
30					100	15 8366 01	...116052
40					100	15 8367 01	...472790
50					100	15 8368 01	...313956

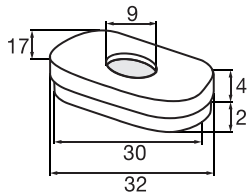
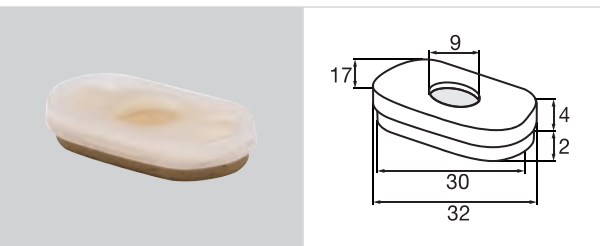

 Ø mm					pcs.	Code	EAN-Code 4001073 ...
35x20					100	16 9514 01	...216622

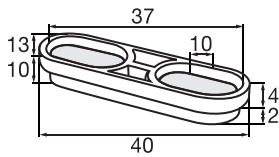
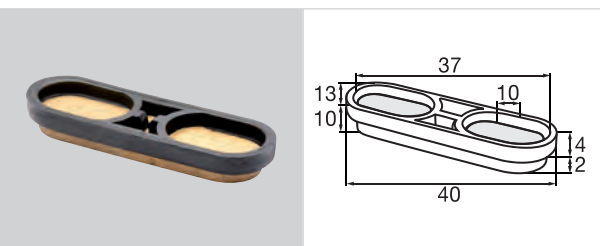

 Ø mm					pcs.	Code	EAN-Code 4001073 ...
39x12					100	16 8989 01	...092158

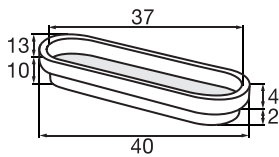
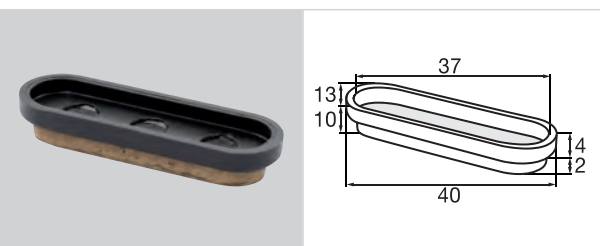

 Ø mm					pcs.	Code	EAN-Code 4001073 ...
39x12					100	16 8991 01	...156058

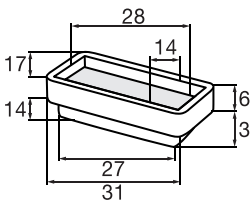
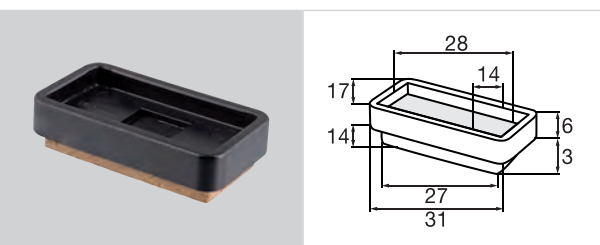

 Ø mm					pcs.	Code	EAN-Code 4001073 ...
31x17					100	16 9549 01	...030181

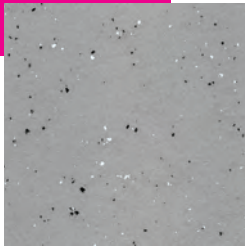

Aufsatz SYNO zum Aufdrücken auf Basis „LOUNGE“ und „EASY LOUNGE“ - besonders geräuscharm

SYNO insert to click onto base „LOUNGE“ and „EASY LOUNGE“ - particularly low noise level

Embout SYNO à enfoncer sur base „LOUNGE“ et „EASY LOUNGE“ - particulièrement silencieux

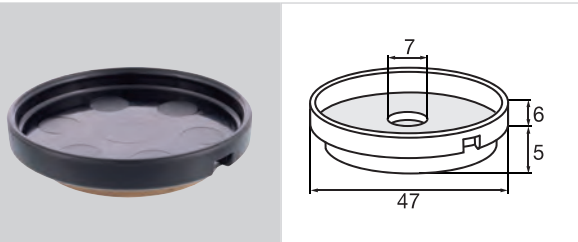

	Ø mm					pcs.	Code	EAN-Code 4001073 ...
	40					100	16 0496 01	...198447

Aufsatz SYNO „SLIM“ zum Aufdrücken auf jede passende Basis - besonders geräuscharm

SYNO „SLIM“ cap to click onto every suitable base - particularly low noise level

Embout SYNO „SLIM“ à enfoncer sur toute base appropriée - particulièrement silencieux

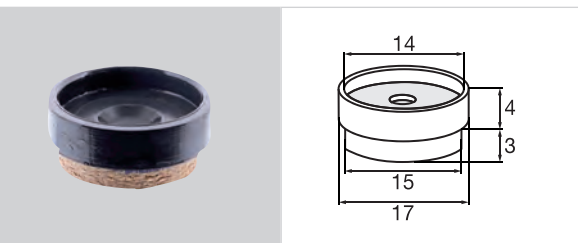

	Ø mm					pcs.	Code	EAN-Code 4001073 ...
	17					100	15 8355 01	...266603

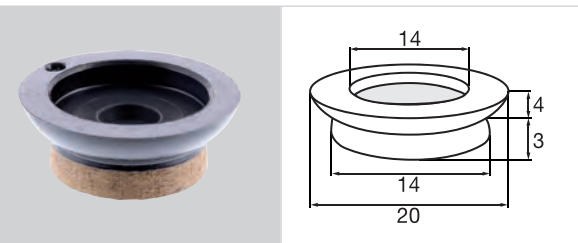

	Ø mm					pcs.	Code	EAN-Code 4001073 ...
	20					100	15 8356 01	...105780

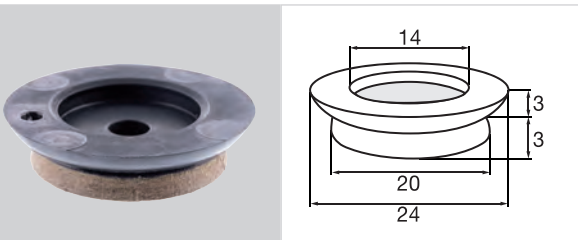

	Ø mm					pcs.	Code	EAN-Code 4001073 ...
	25					100	15 8357 01	...104189

# QuickClick<sup>®</sup> SYNO<sup>®</sup>

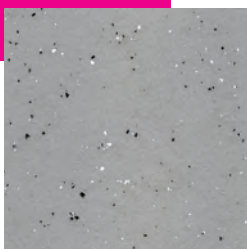

Aufsatz SYNO „SLIM ECO FRIENDLY“ zum Aufdrücken auf jede passende Basis - besonders geräuscharm

SYNO „SLIM ECO FRIENDLY“ cap to click onto every suitable base - particularly low noise level

Embout SYNO „SLIM ECO FRIENDLY“ à enfoncer sur toute base appropriée - particulièrement silencieux



 Ø mm					pcs.	Code	EAN-Code 4001073 ...
17					100	15 8361 01	...203127
17					100	15 8376 01	...302226

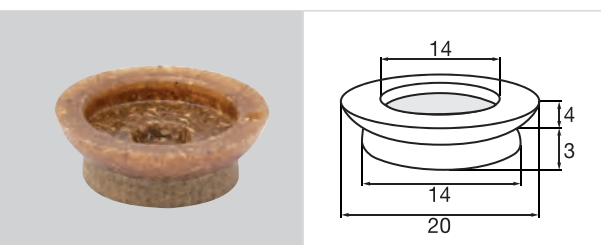

 Ø mm					pcs.	Code	EAN-Code 4001073 ...
20					100	15 8362 01	...400649
20					100	15 8377 01	...159189

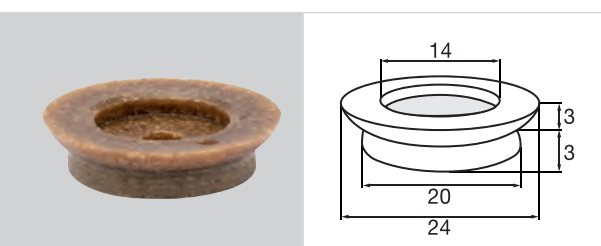



 Ø mm					pcs.	Code	EAN-Code 4001073 ...
25					100	15 8363 01	...009385
25					100	15 8378 01	...456394

Aufsatz SMART SYNO zum Eindrücken in Basis „SMART“

SMART SYNO cap to click into base „SMART“

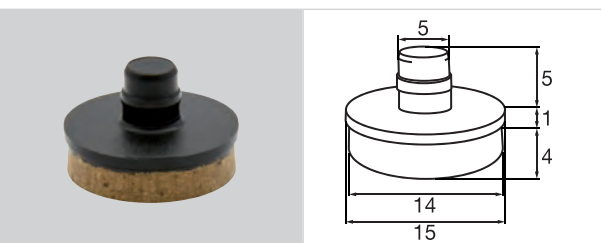
Embout SMART SYNO à enfoncer dans base „SMART“



 Ø mm					pcs.	Code	EAN-Code 4001073 ...
15					100	16 0940 01	...267846
20					100	16 0941 01	...070149



Ein-/Aufsatz HYPER zum Ein-/Aufdrücken in/auf jede passende Basis - beste Gleiteigenschaften!

HYPER insert/cap to click into/onto every suitable base - the best gliding properties!

Insert/Embout HYPER à enfoncer dans/sur chaque base appropriée - meilleures qualités de glissement!

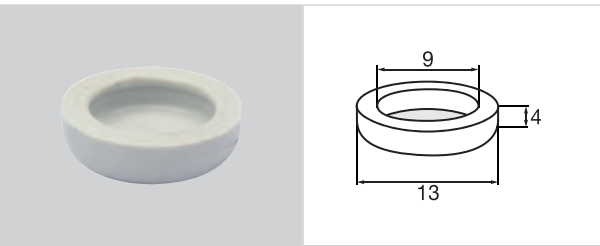

 Ø mm					pcs.	Code	EAN-Code 4001073 ...
13					100	15 7982 01	...337440
13					100	15 7983 01	...015249

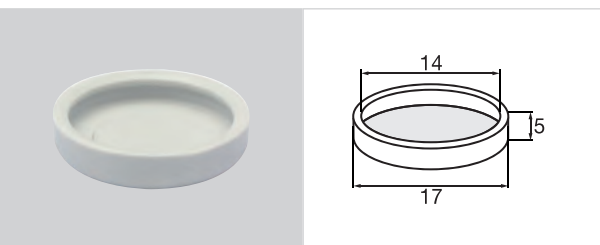

 Ø mm					pcs.	Code	EAN-Code 4001073 ...
17					100	15 7903 01	...492842
17					100	15 7902 01	...492941

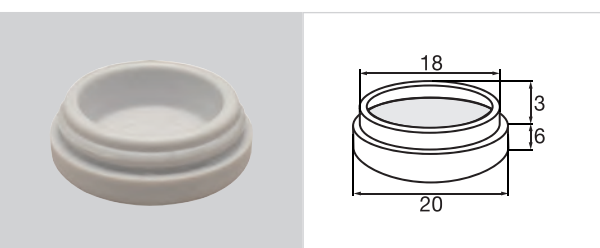

 Ø mm					pcs.	Code	EAN-Code 4001073 ...
20					100	15 7923 01	...491920

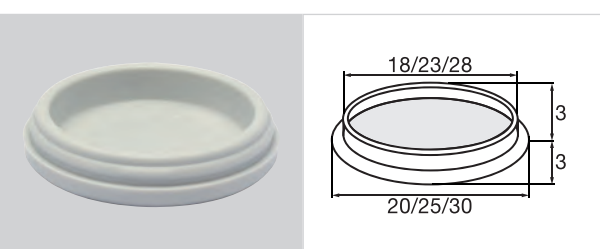

 Ø mm					pcs.	Code	EAN-Code 4001073 ...
20					100	15 7922 01	...492958
25					100	15 7927 01	...493009
30					100	15 7930 01	...493023
30					100	15 7932 01	...493016

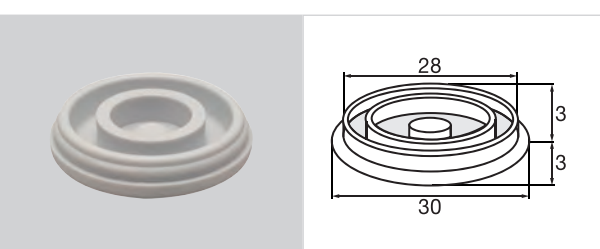

 Ø mm					pcs.	Code	EAN-Code 4001073 ...
25					100	15 7928 01	...492859
30					100	15 7934 01	...493054

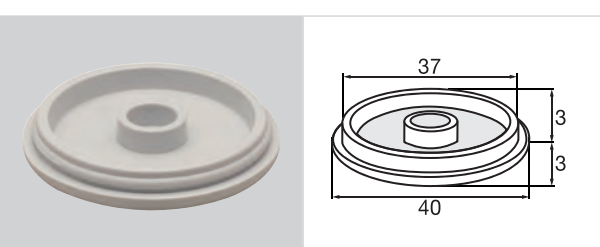

 Ø mm					pcs.	Code	EAN-Code 4001073 ...
40					100	15 7966 01	...493030

# QuickClick<sup>®</sup> HYPER



Ein-/Aufsatz HYPER zum Ein-/Aufdrücken in/auf jede passende Basis - beste Gleiteigenschaften!

HYPER insert/cap to click into/onto every suitable base - the best gliding properties!

Insert/Embout HYPER à enfoncer dans/sur chaque base appropriée - meilleures qualités de glissement!

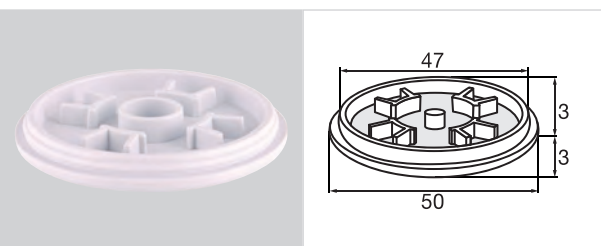

 Ø mm					pcs.	Code	EAN-Code 4001073 ...
50					100	15 7945 01	...493047

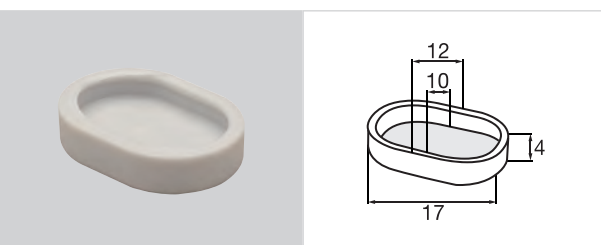

 Ø mm					pcs.	Code	EAN-Code 4001073 ...
17x12					100	15 7984 01	...309683

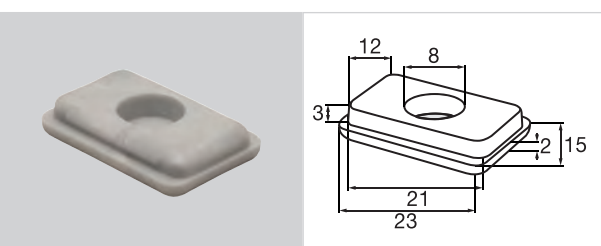

 Ø mm					pcs.	Code	EAN-Code 4001073 ...
23x15					100	15 7972 01	...306989

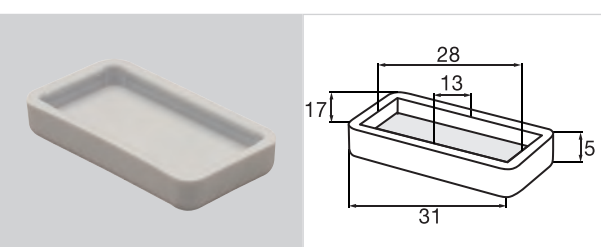

 Ø mm					pcs.	Code	EAN-Code 4001073 ...
31x17					100	15 7918 01	...311976

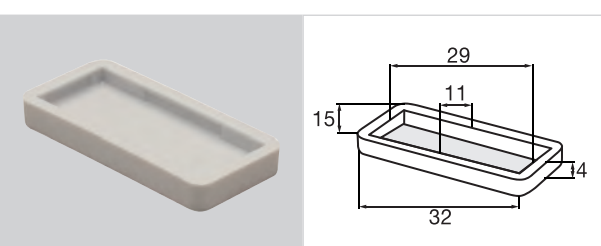

 Ø mm					pcs.	Code	EAN-Code 4001073 ...
32x15					100	15 7917 01	...307870



Ein-/Aufsatz HYPER zum Ein-/Aufdrücken in/auf jede passende Basis - beste Gleiteigenschaften!

HYPER insert/cap to click into/onto every suitable base - the best gliding properties!

Insert/Embout HYPER à enfoncer dans/sur chaque base appropriée - meilleures qualités de glissement!

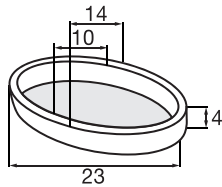

 Ø mm					pcs.	Code	EAN-Code 4001073 ...
23x14					100	15 7913 01	...314380

Kundenspezifischer Artikel hergestellt für  
This article is produced exclusively for  
Article spécifique, fabriqué pour

**arper**

Aufsatz HYPER zum Aufdrücken in jede passende Basis - beste Gleiteigenschaften!

HYPER cap to click into every suitable base - the best gliding properties!

Embout HYPER à enfoncer dans chaque base appropriée - meilleures qualités de glissement!

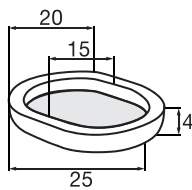

 Ø mm					pcs.	Code	EAN-Code 4001073 ...
20x25					100	15 8995 01	...053302

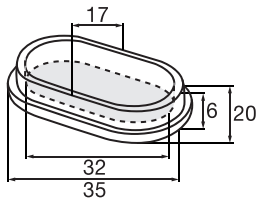

 Ø mm					pcs.	Code	EAN-Code 4001073 ...
35x20					100	15 7912 01	...307993

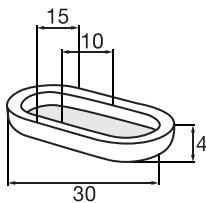

 Ø mm					pcs.	Code	EAN-Code 4001073 ...
30x15					100	15 7931 01	...015256

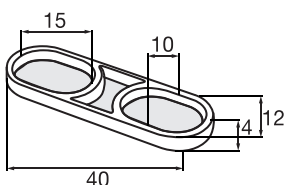
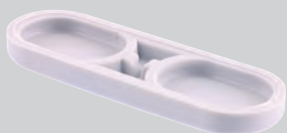

 Ø mm					pcs.	Code	EAN-Code 4001073 ...
39x12					100	15 7919 01	...316186

# QuickClick<sup>®</sup> HYPER



Aufsatz HYPER „SLIM“ zum Aufdrücken auf jede passende Basis - minimale Bauhöhe

HYPER „SLIM“ cap to click onto every suitable base - minimum construction height

Embout HYPER „SLIM“ à enfoncer sur toute base appropriée - hauteur minimale

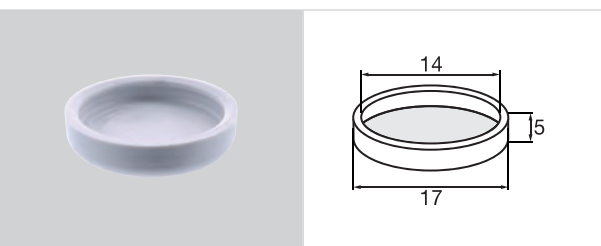

 Ø mm					pcs.	Code	EAN-Code 4001073 ...
17					100	15 7901 01	...069341

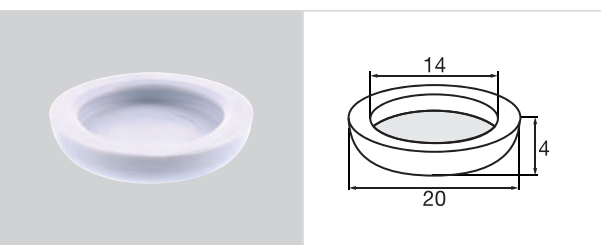

 Ø mm					pcs.	Code	EAN-Code 4001073 ...
20					100	15 7926 01	...492903

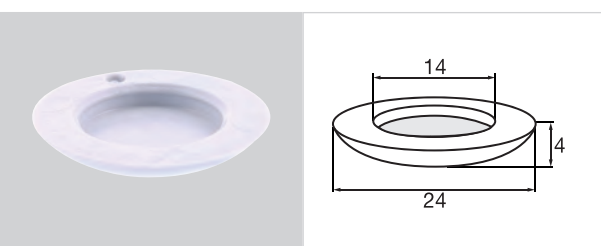



 Ø mm					pcs.	Code	EAN-Code 4001073 ...
25					100	15 7924 01	...492934

Aufsatz HYPER zum Eindrücken in Basis „SMART“

HYPER cap to click into base „SMART“

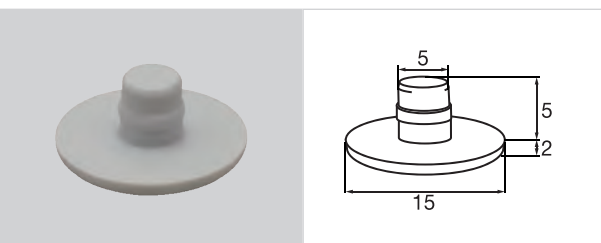
Embout HYPER à enfoncer dans base „SMART“



 Ø mm					pcs.	Code	EAN-Code 4001073 ...
15					100	16 7903 01	...621419
15					100	16 7900 01	...494037
20					100	16 7901 01	...494044





Ein-/Aufsatz SUPER zum Ein-/Aufdrücken in/auf jede passende Basis - beste Gleiteigenschaften!

SUPER insert/cap to click into/onto every suitable base - the best gliding properties!

Insert/embout SUPER à enfoncer dans/sur chaque base appropriée - meilleures qualités de glissement!

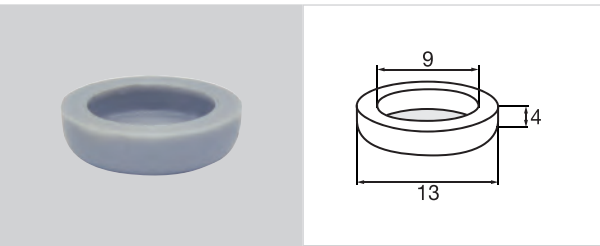

 Ø mm					pcs.	Code	EAN-Code 4001073 ...
13					100	15 8074 01	...014235

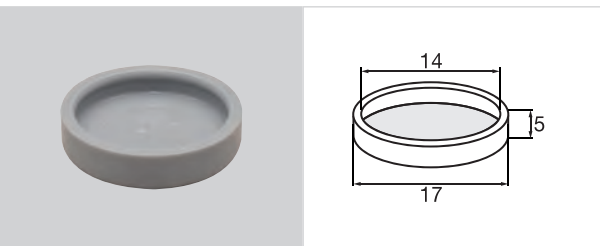

 Ø mm					pcs.	Code	EAN-Code 4001073 ...
17					100	15 8102 01	...297997
17					100	15 8159 01	...306965

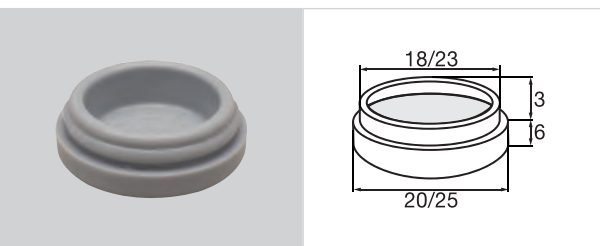

 Ø mm					pcs.	Code	EAN-Code 4001073 ...
20					100	15 8035 01	...491111
25					100	15 8047 01	...492521

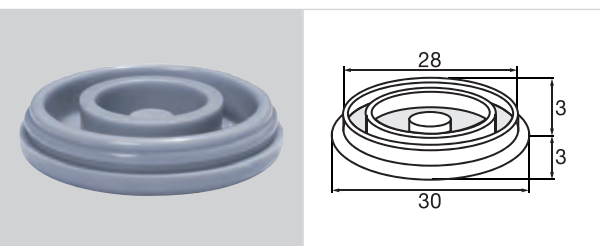

 Ø mm					pcs.	Code	EAN-Code 4001073 ...
13					100	15 8138 01	...491951

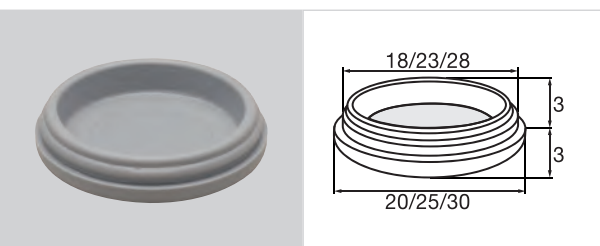

 Ø mm					pcs.	Code	EAN-Code 4001073 ...
20					100	15 8022 01	...488234
25					100	15 8027 01	...488630
30					100	15 8032 01	...489033

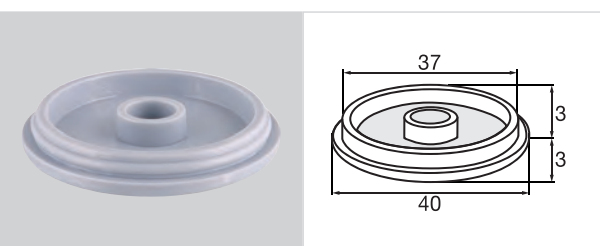

 Ø mm					pcs.	Code	EAN-Code 4001073 ...
40					100	15 8266 01	...046014
40					100	15 8269 01	...046021

# QuickClick<sup>®</sup> SUPER



Ein-/Aufsatz SUPER zum Ein-/Aufdrücken in/auf jede passende Basis - beste Gleiteigenschaften!

SUPER insert/cap to click into/onto every suitable base - the best gliding properties!

Insert/embout SUPER à enfoncer dans/sur chaque base appropriée - meilleures qualités de glissement!

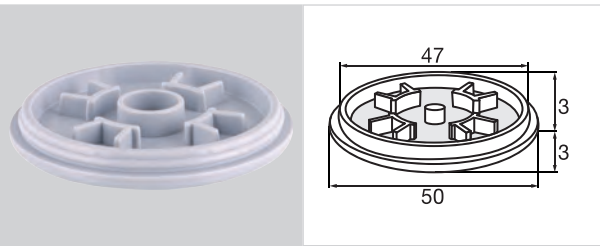

 Ø mm					pcs.	Code	EAN-Code 4001073 ...
50					100	15 8045 01	...047042

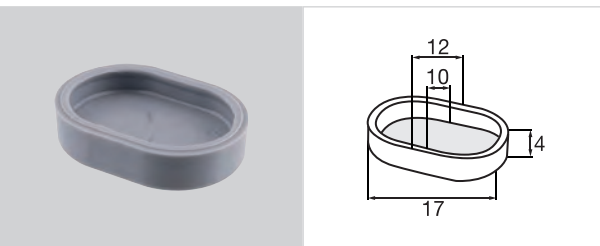

 Ø mm					pcs.	Code	EAN-Code 4001073 ...
17x12					100	15 8984 01	...309065
17x12					100	15 8985 01	...308976

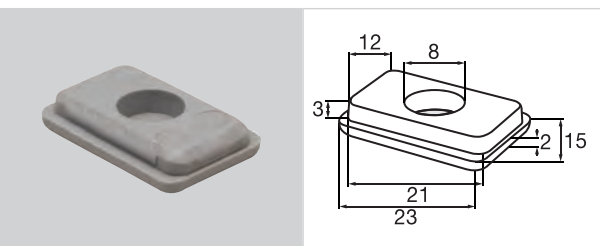

 Ø mm					pcs.	Code	EAN-Code 4001073 ...
23x15					100	15 8973 01	...306477

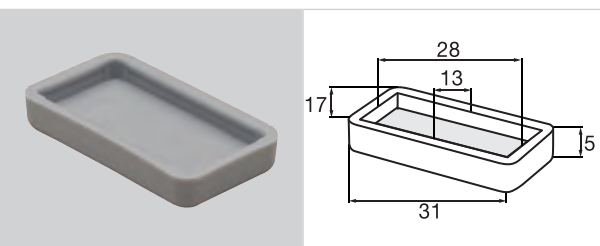

 Ø mm					pcs.	Code	EAN-Code 4001073 ...
31x17					100	16 9544 01	...329162
31x17					100	15 9544 01	...311792

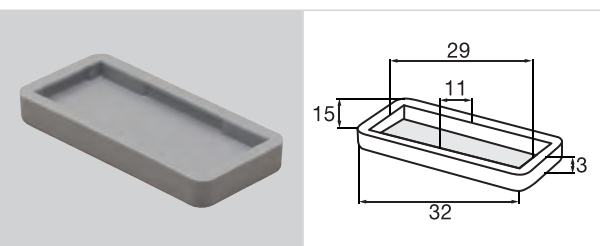

 Ø mm					pcs.	Code	EAN-Code 4001073 ...
32x15					100	15 9507 01	...300895



Ein-/Aufsatz SUPER zum Ein-/Aufdrücken in/auf jede passende Basis - beste Gleiteigenschaften!

SUPER insert/cap to click into/onto every suitable base - the best gliding properties!

Insert/embout SUPER à enfoncer dans/sur chaque base appropriée - meilleures qualités de glissement!

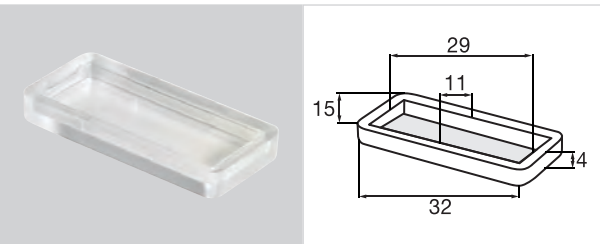

 Ø mm					pcs.	Code	EAN-Code 4001073 ...
32x15					100	15 9547 01	...309287

Aufsatz SUPER zum Aufdrücken auf jede passende Basis - beste Gleiteigenschaften!

SUPER cap to click onto every suitable base - the best gliding properties!

Embout SUPER à enfoncer sur chaque base appropriée - meilleures qualités de glissement!

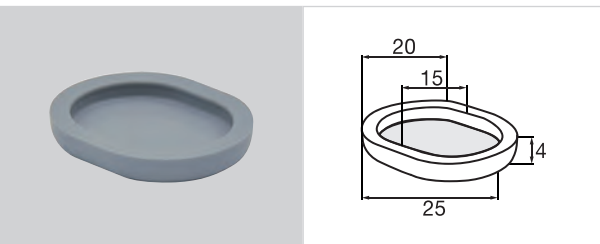

 Ø mm					pcs.	Code	EAN-Code 4001073 ...
20x25					100	15 8996 01	...053319

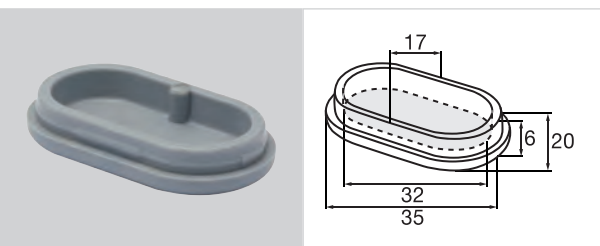

 Ø mm					pcs.	Code	EAN-Code 4001073 ...
35x20					100	15 9502 01	...299298
35x20					100	15 9552 01	...307689
35x20					100	15 9509 01	...306484

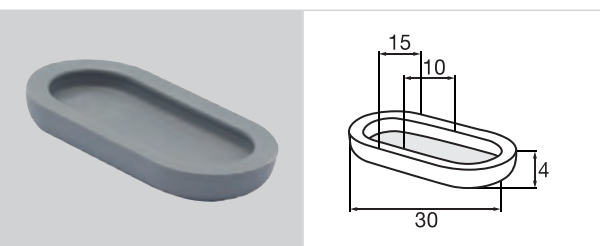

 Ø mm					pcs.	Code	EAN-Code 4001073 ...
30x15					100	15 8921 01	...014259

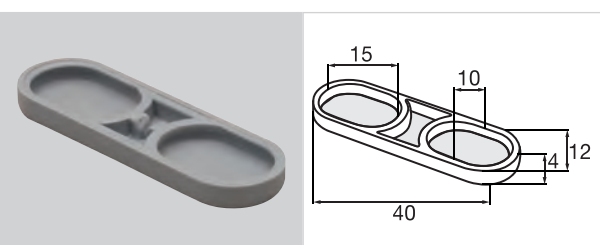

 Ø mm					pcs.	Code	EAN-Code 4001073 ...
39x12					100	15 9543 01	...316179
39x12					100	15 9541 01	...317169
39x12					100	15 9542 01	...317091

# QuickClick<sup>®</sup> SUPER

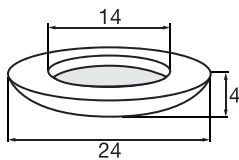
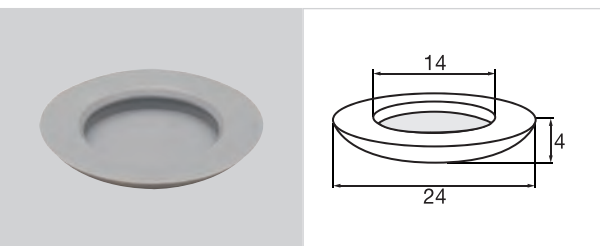
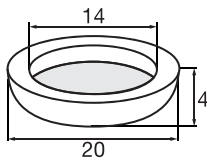
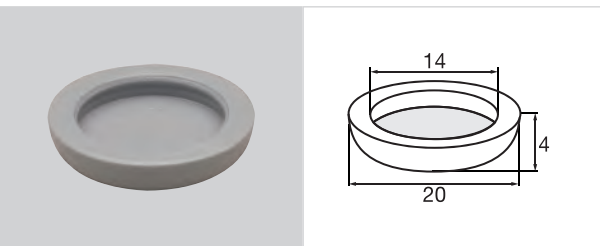
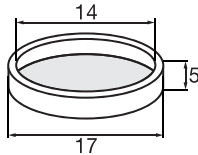
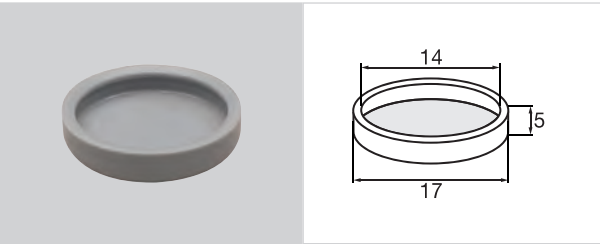

Aufsatz SUPER „SLIM“ zum Aufdrücken auf jede passende Basis - minimale Bauhöhe

SUPER „SLIM“ cap to click onto every suitable base - minimum construction height

Embout SUPER „SLIM“ à enficher sur chaque base appropriée - hauteur minimale

	Ø mm					pcs.	Code	EAN-Code 4001073 ...
	17					100	15 8112 01	...307078

	Ø mm					pcs.	Code	EAN-Code 4001073 ...
	20					100	15 8068 01	...020939

	Ø mm					pcs.	Code	EAN-Code 4001073 ...
	25					100	15 8075 01	...491937

Aufsatz SUPER zum Eindrücken in Basis „SMART“

SUPER cap to click into base „SMART“

Embout SUPER à enfoncer dans base „SMART“

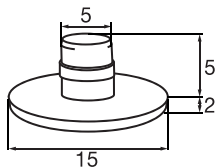
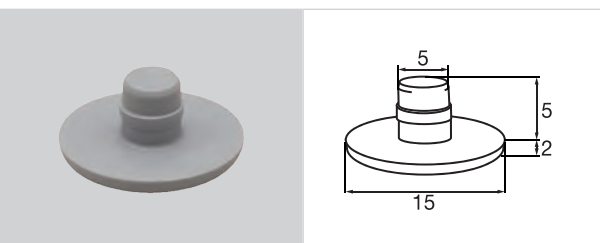

	Ø mm					pcs.	Code	EAN-Code 4001073 ...
	15					100	16 0450 01	...494204
	20					100	16 0451 01	...494211



Ein-/Aufsatz BLACK zum Ein-/Aufdrücken in/auf jede passende Basis  
 BLACK insert/cap to click into/onto every suitable base  
 Insert/embout BLACK à enfoncer dans/sur chaque base appropriée

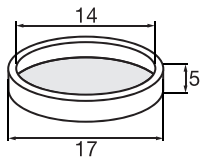
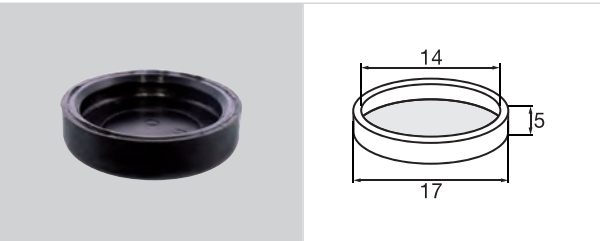

	Ø mm					pcs.	Code	EAN-Code 4001073 ...
	17					100	15 8100 01	...297973

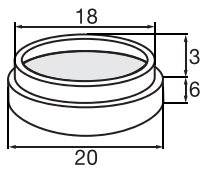



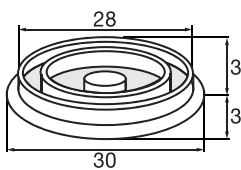
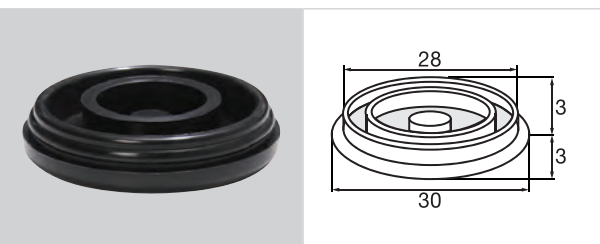

	Ø mm					pcs.	Code	EAN-Code 4001073 ...
	20					100	16 8035 01	...494952

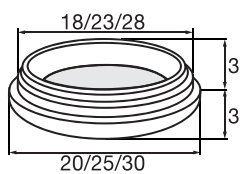
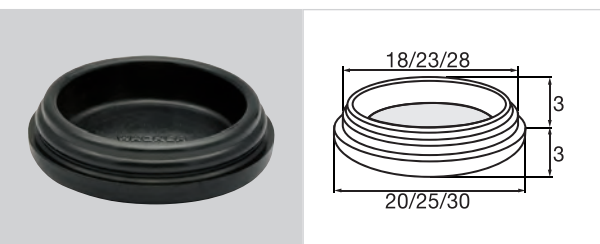

	Ø mm					pcs.	Code	EAN-Code 4001073 ...
	30					100	15 8224 01	...308792



	Ø mm					pcs.	Code	EAN-Code 4001073 ...
	20					100	15 8219 01	...298277
	25					100	15 8222 01	...298284
	30					100	15 8227 01	...298291

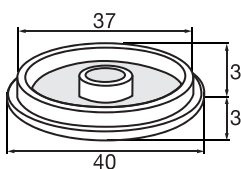
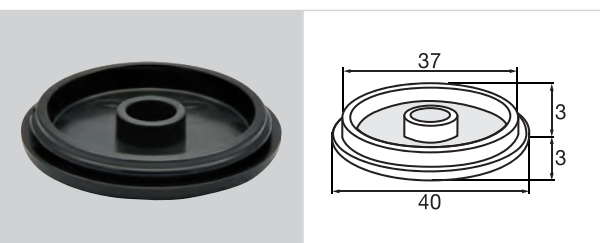

	Ø mm					pcs.	Code	EAN-Code 4001073 ...
	40					100	15 8268 01	...306286

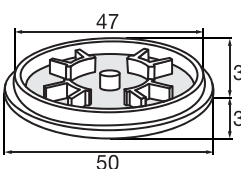
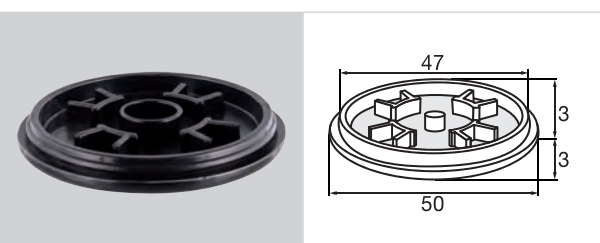

	Ø mm					pcs.	Code	EAN-Code 4001073 ...
	50					100	15 8249 01	...298369

# QuickClick<sup>®</sup> BLACK



Ein-/Aufsatz BLACK zum Ein-/Aufdrücken in/auf jede passende Basis  
 BLACK insert/cap to click into/onto every suitable base  
 Insert/embout BLACK à enfoncer dans/sur chaque base appropriée

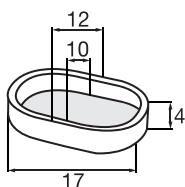
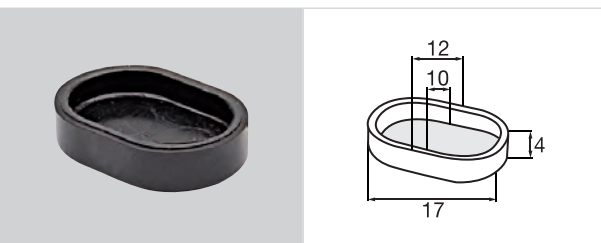

 Ø mm					pcs.	Code	EAN-Code 4001073 ...
17x12					100	15 8981 01	...309072

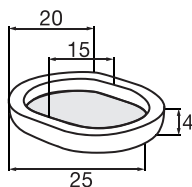
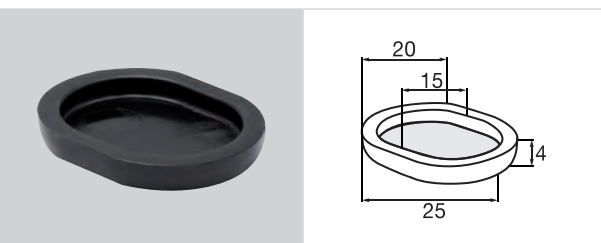

 Ø mm					pcs.	Code	EAN-Code 4001073 ...
20x25					100	15 8979 01	...053111

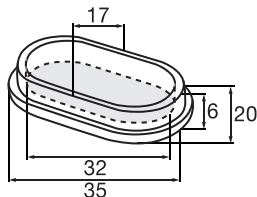
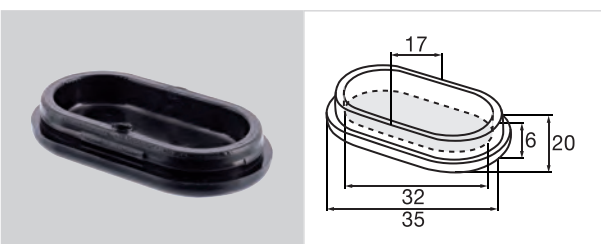

 Ø mm					pcs.	Code	EAN-Code 4001073 ...
35x20					100	15 9500 01	...299274

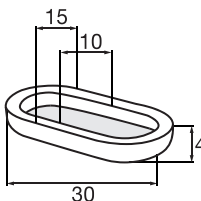
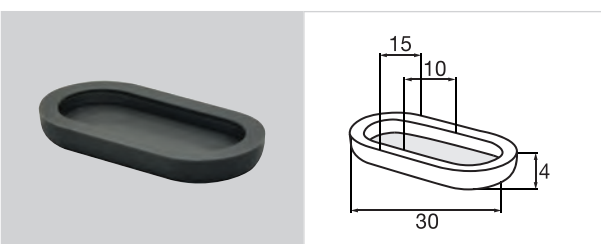

 Ø mm					pcs.	Code	EAN-Code 4001073 ...
30x15					100	15 8127 01	...325393

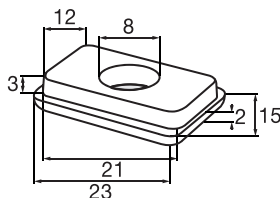
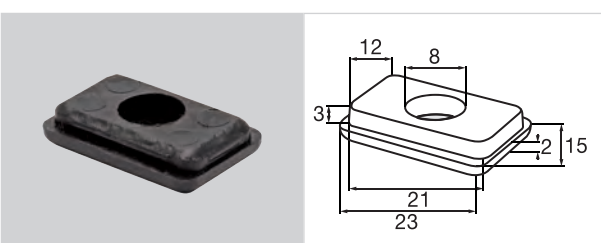

 Ø mm					pcs.	Code	EAN-Code 4001073 ...
23x15					100	15 8972 01	...306378

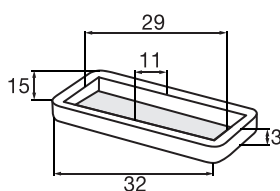
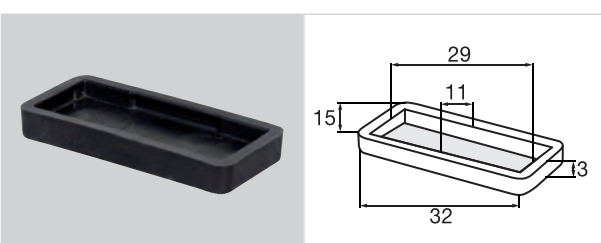

 Ø mm					pcs.	Code	EAN-Code 4001073 ...
32x15					100	15 7916 01	...293296



Ein-/Aufsatz BLACK zum Ein-/Aufdrücken in/auf jede passende Basis  
BLACK insert/cap to click into/onto every suitable base  
Insert/embout BLACK à enfoncer dans/sur chaque base appropriée

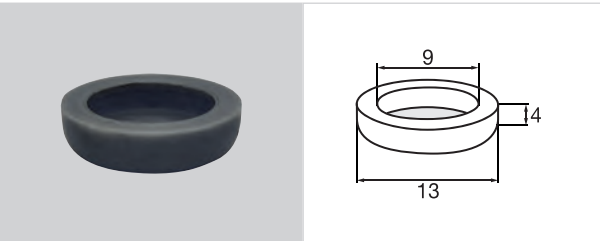

	Ø mm					pcs.	Code	EAN-Code 4001073 ...
	13					100	15 8079 01	...015836

Aufsatz BLACK „SLIM“ zum Aufdrücken auf jede passende Basis -  
minimale Bauhöhe  
BLACK „SLIM“ cap to click onto every suitable base -  
minimum construction height  
Embout BLACK „SLIM“ à enficher sur chaque base appropriée -  
hauteur minimale

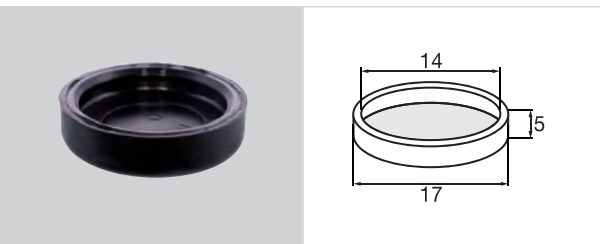

	Ø mm					pcs.	Code	EAN-Code 4001073 ...
	17					100	15 8121 01	...307368

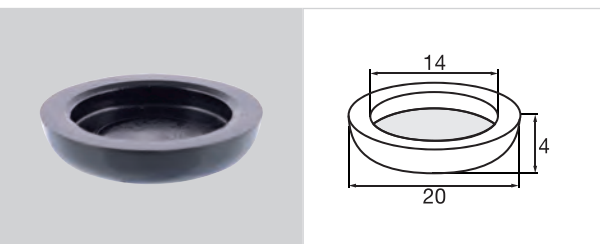

	Ø mm					pcs.	Code	EAN-Code 4001073 ...
	20					100	15 8289 01	...052336

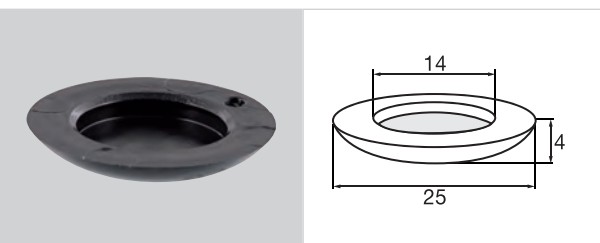

	Ø mm					pcs.	Code	EAN-Code 4001073 ...
	25					100	15 8223 01	...304299



# QuickClick® BLACK



Aufsatz SMART BLACK zum Eindrücken in Basis „SMART“  
 SMART BLACK cap to click into base „SMART“  
 Embout SMART BLACK à enfoncer dans base „SMART“

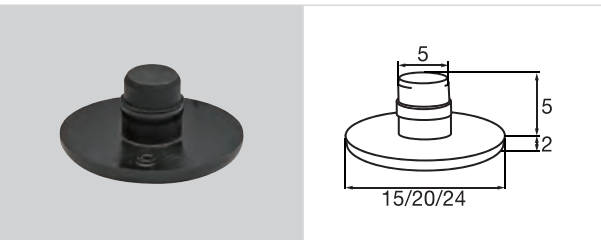

 Ø mm					pcs.	Code	EAN-Code 4001073 ...
15					100	16 0446 01	...494051
20					100	16 0447 01	...494105
26					100	16 0935 01	...398045

Aufsatz SMART BLACK zum Eindrücken in Basis  
 SMART BLACK cap to click into base  
 Embout SMART BLACK à enfoncer dans base

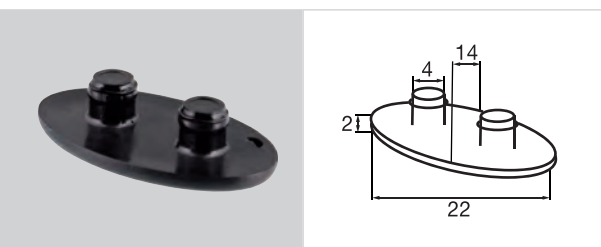

 Ø mm					pcs.	Code	EAN-Code 4001073 ...
23x14					100	16 8045 01	...005981





Ein-/Aufsatz EXTREME zum Ein-/Aufdrücken in/auf jede passende Basis - besonders robust für extreme Ansprüche

EXTREME insert/cap to click into/onto every suitable base - particularly robust for extreme requirements

Insert/embout EXTREME à enfoncer dans/sur chaque base appropriée - particulièrement robuste pour exigences extrêmes

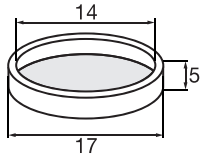
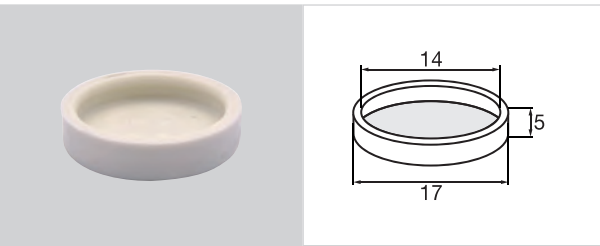

 Ø mm					pcs.	Code	EAN-Code 4001073 ...
17					100	15 8215 01	...334470

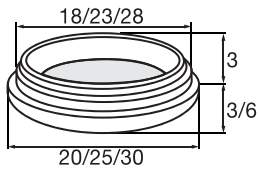
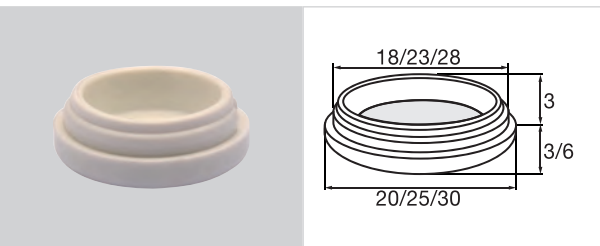

 Ø mm					pcs.	Code	EAN-Code 4001073 ...
20					100	15 8218 01	...316070
25					100	15 8217 01	...324792
30					100	15 8213 01	...418149

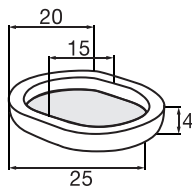
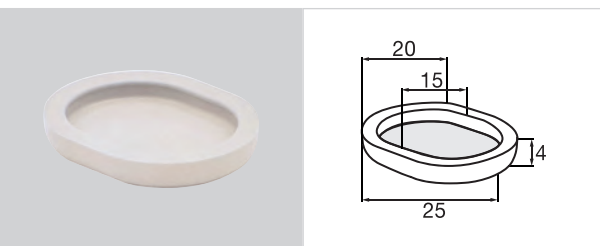

 Ø mm					pcs.	Code	EAN-Code 4001073 ...
20x25					100	16 8970 01	...057546

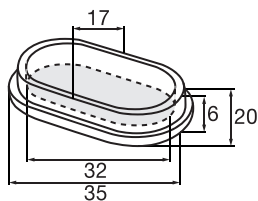
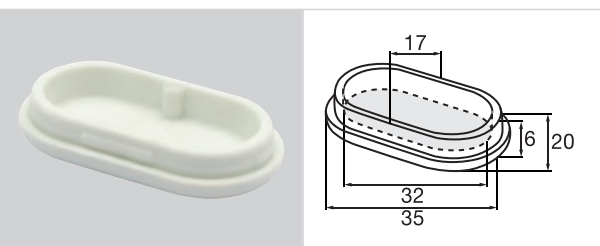

 Ø mm					pcs.	Code	EAN-Code 4001073 ...
35x20					100	15 7914 01	...292053

# QuickClick<sup>®</sup> EXTREME



Aufsatz EXTREME „SLIM“ zum Aufdrücken auf jede passende Basis - minimale Bauhöhe

EXTREME „SLIM“ cap to click onto every suitable base - minimum construction height

Embout EXTREME „SLIM“ à enficher sur chaque base appropriée - hauteur minimale

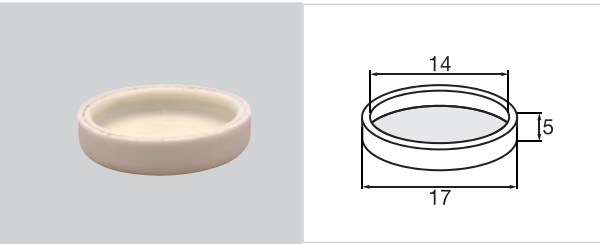

	Ø mm					pcs.	Code	EAN-Code 4001073 ...
	17					100	15 8234 01	...219425

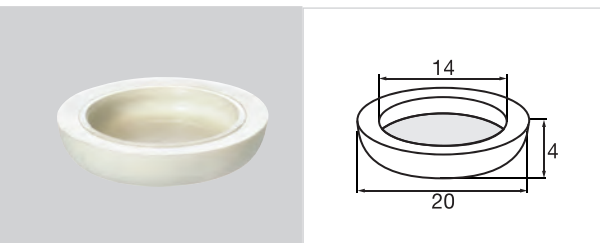

	Ø mm					pcs.	Code	EAN-Code 4001073 ...
	20					100	15 8229 01	...323085

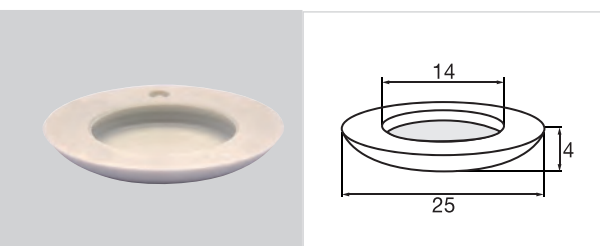



	Ø mm					pcs.	Code	EAN-Code 4001073 ...
	25					100	15 8216 01	...330595

Aufsatz EXTREME zum Eindrücken in Basis „SMART“

EXTREME cap to click into base „SMART“

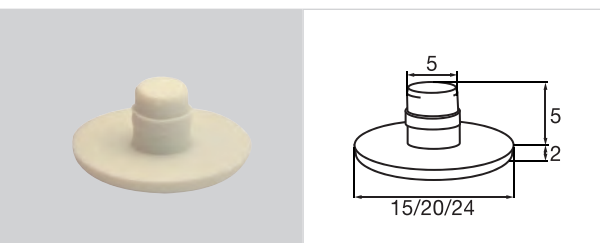
Embout EXTREME à enfoncer dans base „SMART“





	Ø mm					pcs.	Code	EAN-Code 4001073 ...
	15					100	16 0448 01	...494136
	20					100	16 0449 01	...494143
	26					100	16 0937 01	...314205
	26					100	16 0938 01	...473360



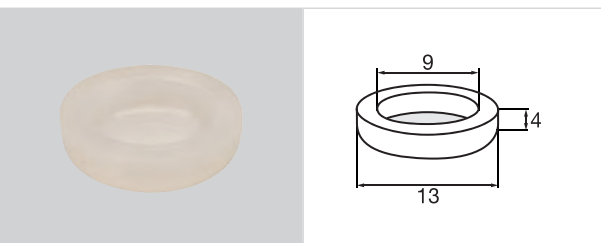

Ein-/Aufsatz STOPP zum Ein-/Aufdrücken in/auf jede passende Basis  
 STOPP insert/cap to click into/onto every suitable base  
 Insert/embout STOPP à enfoncer dans/sur chaque base appropriée

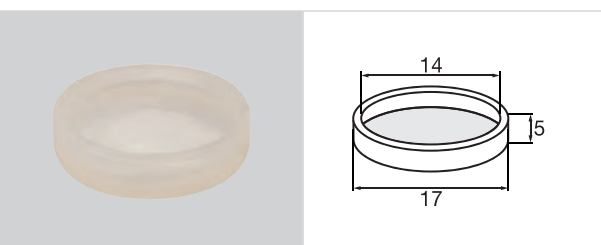

 Ø mm	pcs.	Code	EAN-Code 4001073 ...
 13	100	16 8072 01	...330687
 13	100	16 8073 01	...356236



 Ø mm	pcs.	Code	EAN-Code 4001073 ...
 17	100	15 8101 01	...297980
 17	100	16 8100 01	...329889

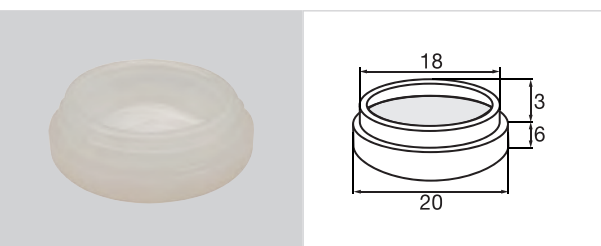



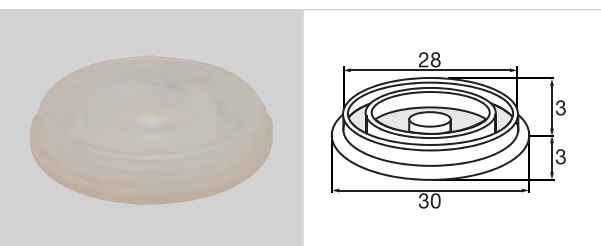

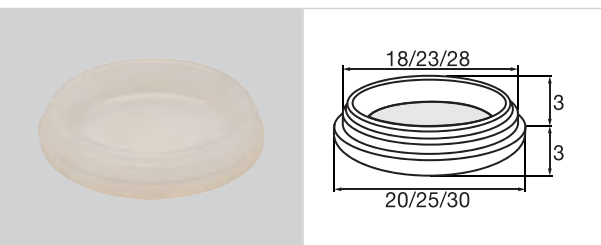

 Ø mm	pcs.	Code	EAN-Code 4001073 ...
 20	100	15 8036 01	...491906



 Ø mm	pcs.	Code	EAN-Code 4001073 ...
 30	100	15 8280 01	...050332



 Ø mm	pcs.	Code	EAN-Code 4001073 ...
 20	100	15 8244 01	...046601
 25	100	15 8245 01	...046557
 30	100	15 8246 01	...046540
 20	100	15 8282 01	...048735
 30	100	15 8240 01	...218923

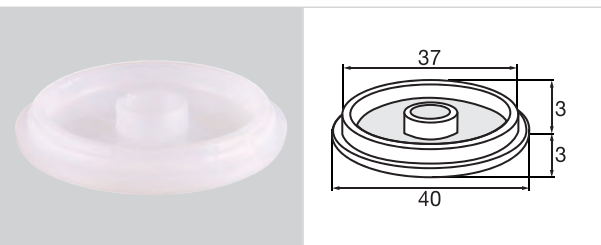



 Ø mm	pcs.	Code	EAN-Code 4001073 ...
 40	100	15 8267 01	...046007

# QuickClick<sup>®</sup> STOPP

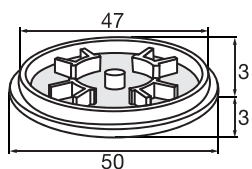
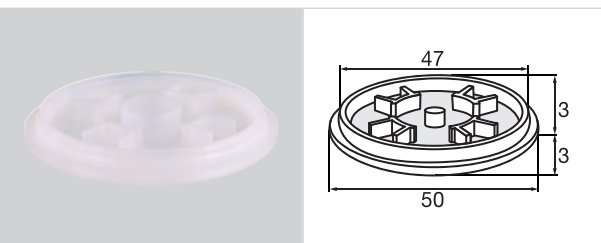

Ein-/Aufsatz STOPP zum Ein-/Aufdrücken in/auf jede passende Basis  
 STOPP insert/cap to click into/onto every suitable base  
 Insert/embout STOPP à enfoncer dans/sur chaque base appropriée



 $\emptyset$ mm	pcs.	Code	EAN-Code 4001073 ...
50	100	15 8247 01	...047059
50	100	16 8103 01	...102741

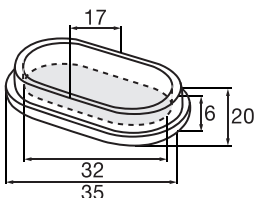
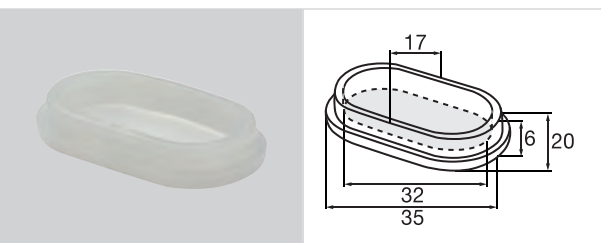

 $\emptyset$ mm	pcs.	Code	EAN-Code 4001073 ...
35x20	100	15 9501 01	...299281

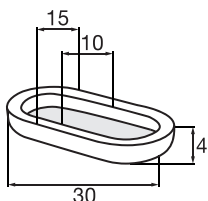
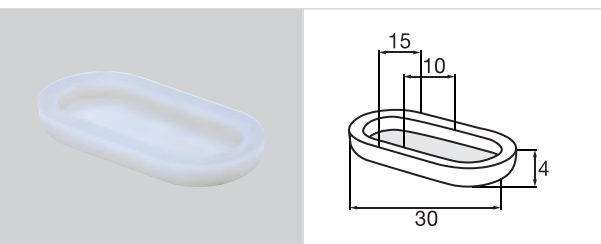

 $\emptyset$ mm	pcs.	Code	EAN-Code 4001073 ...
30x15	100	16 8126 01	...330977

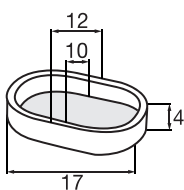
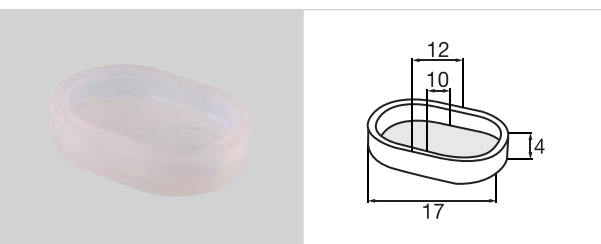

 $\emptyset$ mm	pcs.	Code	EAN-Code 4001073 ...
17x12	100	15 8987 01	...312089



Aufsatz STOPP zum Aufdrücken auf jede passende Basis  
STOPP cap to click onto every suitable base  
Insert STOPP à enfoncer sur chaque base appropriée

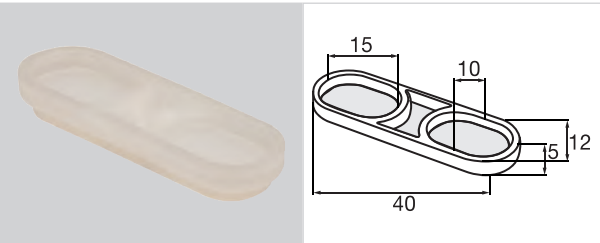

 Ø mm	pcs.	Code	EAN-Code 4001073 ...
39x12	100	15 9540 01	...318166

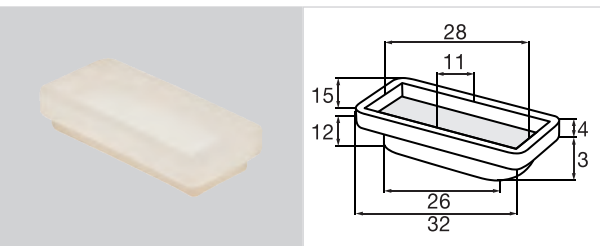

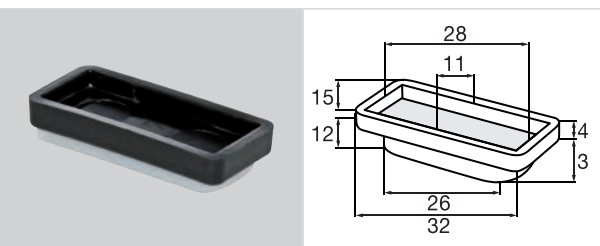

 Ø mm	pcs.	Code	EAN-Code 4001073 ...
32x15	100	16 9508 01	...267730



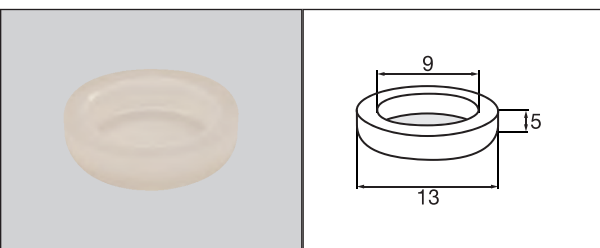

 Ø mm	pcs.	Code	EAN-Code 4001073 ...
32x15	100	15 9508 01	...307986

Aufsatz STOPP LIGHT zum Aufdrücken auf jede passende Basis  
STOPP LIGHT cap to click onto every suitable base  
Insert STOPP LIGHT à enfoncer sur chaque base appropriée

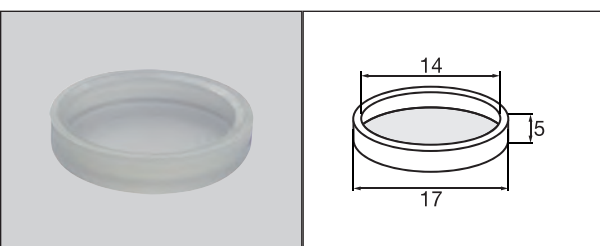

 Ø mm	pcs.	Code	EAN-Code 4001073 ...
13	100	15 8143 01	...326970
13	100	15 8184 01	...103649



 Ø mm	pcs.	Code	EAN-Code 4001073 ...
17	100	15 8140 01	...326260

# QuickClick® STOPP



Aufsatz STOPP „SLIM“ zum Aufdrücken auf jede passende Basis - minimale Bauhöhe

STOPP „SLIM“ cap to click onto every suitable base - minimum construction height

Insert STOPP „SLIM“ à enfoncer sur chaque base appropriée - hauteur minimale

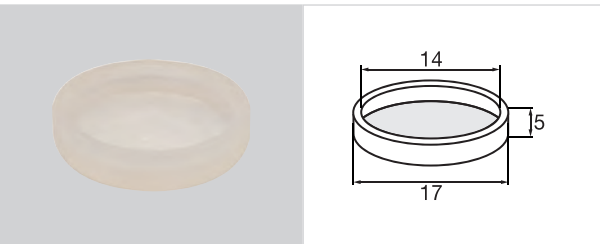



 Ø mm					pcs.	Code	EAN-Code 4001073 ...
17					100	15 8128 01	...329469
17					100	15 8111 01	...307061

Aufsatz STOPP LIGHT „SLIM“ zum Aufdrücken auf jede passende Basis - minimale Bauhöhe

STOPP LIGHT „SLIM“ cap to click onto every suitable base - minimum construction height

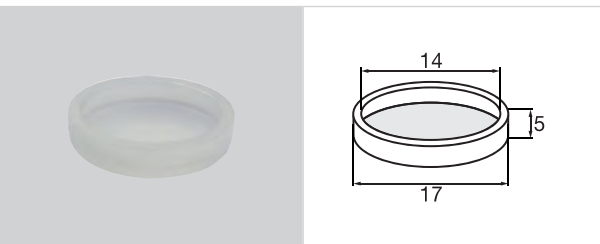
Insert STOPP LIGHT „SLIM“ à enfoncer sur chaque base appropriée - hauteur minimale



 Ø mm					pcs.	Code	EAN-Code 4001073 ...
17					100	15 8142 01	...326284
17					100	15 8210 01	...452662

Aufsatz STOPP LIGHT zum Eindrücken in Basis „SMART“

STOPP LIGHT cap to click into base „SMART“

Embout STOPP LIGHT à enfoncer dans base „SMART“

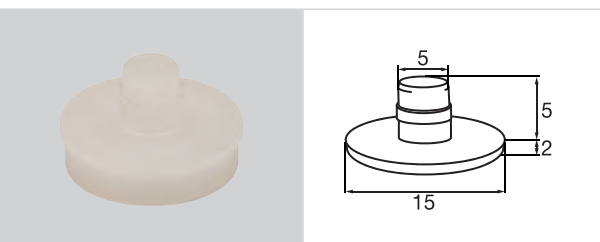

 Ø mm					pcs.	Code	EAN-Code 4001073 ...
15					100	16 7902 01	...038361

## QuickClick® DUO

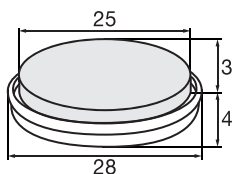
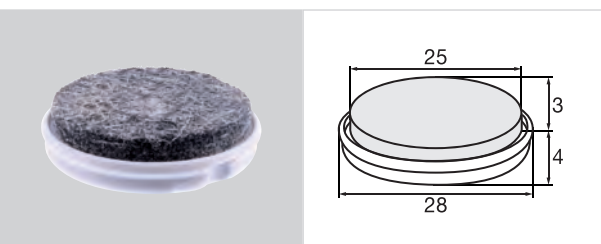

Einsatz „DUO“ ULTRASOFT/HYPER zum Eindrücken in jede passende Basis – wendbarer Gleiteinsatz

„DUO“ ULTRASOFT/HYPER insert to click into every suitable base – reversible insert

Insert „DUO“ ULTRASOFT/HYPER à enfoncer dans chaque base appropriée – avec insert réversible

 Ø mm					pcs.	Code	EAN-Code 4001073 ...
20					100	15 8293 01	...052534
25					100	15 8262 01	...052527
30					100	15 8277 01	...052312
40					100	15 8328 01	...067231

## QuickClick® DUO

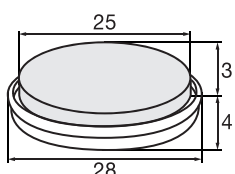

Einsatz „DUO“ ULTRASOFT/STOPP zum Eindrücken in jede passende Basis – wendbarer Gleiteinsatz

„DUO“ ULTRASOFT/STOPP insert to click into every suitable base – reversible insert

Insert „DUO“ ULTRASOFT/STOPP à enfoncer dans chaque base appropriée – avec insert réversible

 Ø mm					pcs.	Code	EAN-Code 4001073 ...
20					100	15 8409 01	...220445
30					100	15 8271 01	...045840

## QuickClick® DUO

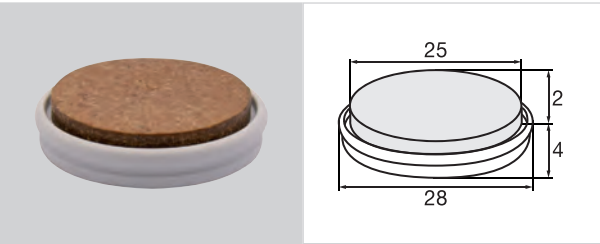

Einsatz „DUO“ SYNO/HYPER zum Eindrücken in jede passende Basis – wendbarer Gleiteinsatz

„DUO“ SYNO/HYPER insert to click into every suitable base – reversible insert

Insert „DUO“ SYNO/HYPER à enfoncer dans chaque base appropriée – avec insert réversible

 Ø mm					pcs.	Code	EAN-Code 4001073 ...
20					100	15 8347 01	...256352
25					100	15 8348 01	...058901
30					100	15 8349 01	...058451
40					100	15 8350 01	...089585

## QuickClick® DUO

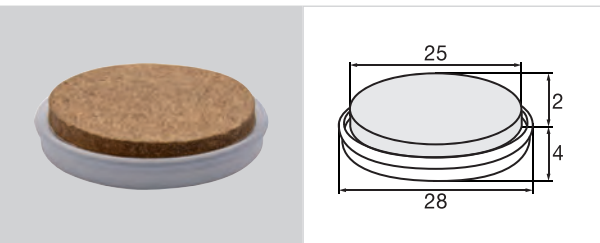

Einsatz „DUO“ SYNO/STOPP zum Eindrücken in jede passende Basis – wendbarer Gleiteinsatz

„DUO“ SYNO/STOPP insert to click into every suitable base – reversible insert

Insert „DUO“ SYNO/STOPP à enfoncer dans chaque base appropriée – avec insert réversible

 Ø mm					pcs.	Code	EAN-Code 4001073 ...
20					100	15 8351 01	...089578
25					100	15 8352 01	...058444
30					100	15 8353 01	...059205
40					100	15 8354 01	...257038



Zubehör für die Befestigung der Basis am Möbel oder Objekt  
Accessories for attaching the base to the furniture or object  
Accessoires pour fixation de la base aux meubles ou objets

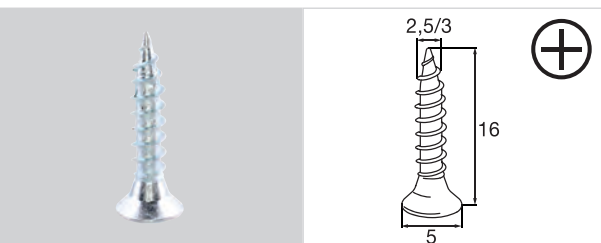

DIN	M x	pcs.	Code	EAN-Code 4001073 ...
WN57	2,5x16	100	40 9297 01	...008340
WN57	3x16	100	40 9289 01	...008401

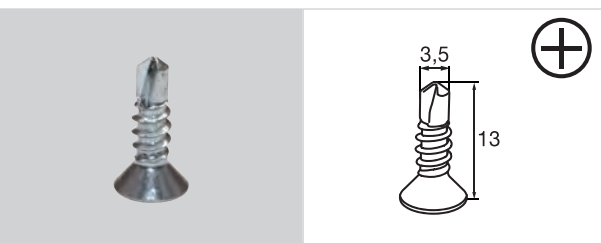

DIN	M x	pcs.	Code	EAN-Code 4001073 ...
WN7504	3,5x13	100	40 9299 01	...160031

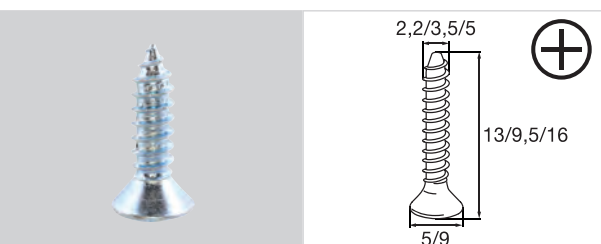

DIN	M x	pcs.	Code	EAN-Code 4001073 ...
7982	2,2x13	100	40 9282 01	...008746
7982	3,5x9,5	100	40 9284 01	...014037
7983	5x16	100	40 9281 01	...008456

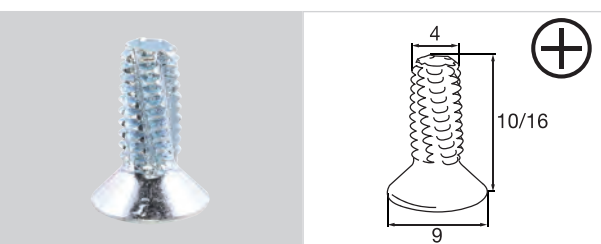

DIN	M x	pcs.	Code	EAN-Code 4001073 ...
7516	4x10	100	40 9279 01	...008647
7516	4x16	100	40 9280 01	...008449



DIN	M x	pcs.	Code	EAN-Code 4001073 ...
7991	5x10	100	40 9314 01	...213102

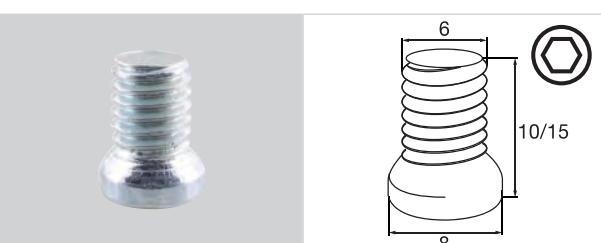

DIN	M x	pcs.	Code	EAN-Code 4001073 ...
WS01	6x10	100	40 9287 01	...008357
WS2	6x15	100	40 9278 01	...008258

Zubehör für die Befestigung der Basis am Möbel oder Objekt  
Accessories for attaching the base to the furniture or object  
Accessoires pour fixation de la base aux meubles ou objets

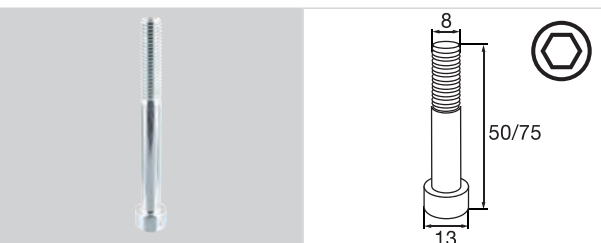

DIN	M x	pcs.	Code	EAN-Code 4001073 ...
6912	8x50	100	40 9275 01	...008142
6912	8x75	100	40 9276 01	...008241

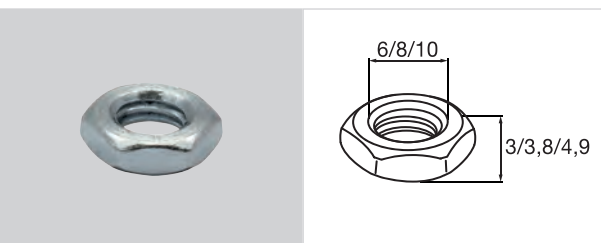

DIN	M x	pcs.	Code	EAN-Code 4001073 ...
439ZN	6	100	13 0177 01	...352603
439ZN	8	100	13 0178 01	...154634
439ZN	10	100	13 0179 01	...550658

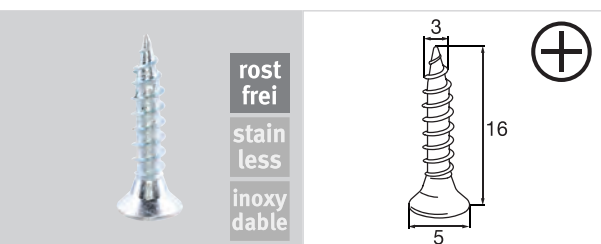

DIN	M x	pcs.	Code	EAN-Code 4001073 ...
WN57	3x16	100	40 9322 01	...201048

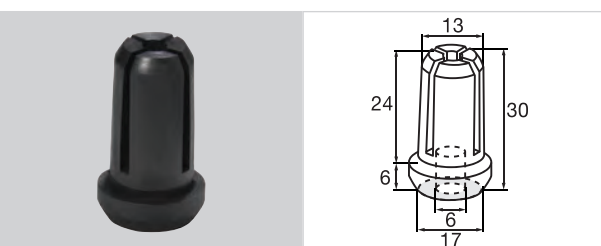

Symbol	pcs.	Code	EAN-Code 4001073 ...
17/13	100	15 9532 01	...306194

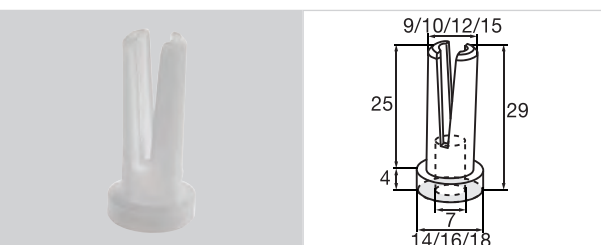

Symbol	pcs.	Code	EAN-Code 4001073 ...
14/9	100	15 9530 01	...305968
14/10	100	15 9531 01	...305975
16/12	100	15 9528 01	...311693
18/15	100	15 9536 01	...317077

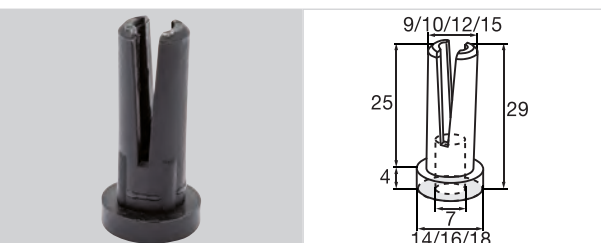









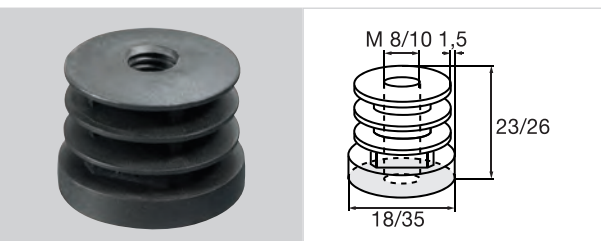



Symbol	pcs.	Code	EAN-Code 4001073 ...
14/9	100	15 9534 01	...307580
14/10	100	16 9535 01	...031478
14/10	100	15 9535 01	...307597
16/12	100	15 9533 01	...314366
18/14	100	16 9538 01	...334661
18/15	100	15 9537 01	...317084
18/15	100	16 9536 01	...415650

Zubehör für die Befestigung der Basis am Möbel oder Objekt









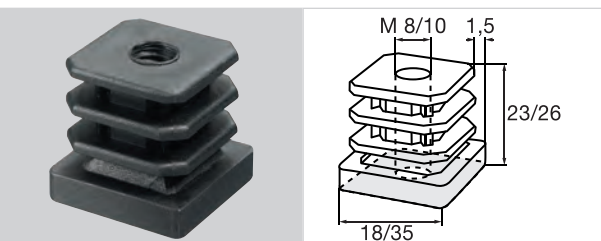



Accessories for attaching the base to the furniture or object

Accessoires pour fixation de la base aux meubles ou objets





	Ø mm	M x			pcs.	Code	EAN-Code 4001073 ...
	18x1,5	8			100	11 0371 01	...299571
	20x1,5	8			100	11 0373 01	...299588
	22x1,5	8			100	11 0374 01	...299595
	25x1,5	8			100	11 0375 01	...299663
	30x1,5	8			100	11 0377 01	...308075
	35x1,5	8			100	11 0376 01	...299670
	18x1,5	10			100	11 0381 01	...299687
	20x1,5	10			100	11 0383 01	...032116
	22x1,5	10			100	11 0384 01	...299694
	25x1,5	10			100	11 0399 01	...032314
	35x1,5	10			100	11 0396 01	...299762

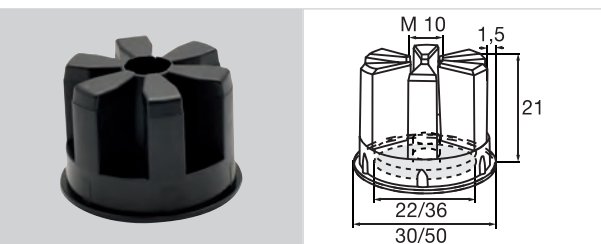

	Ø mm	M x			pcs.	Code	EAN-Code 4001073 ...
	18x18x1,5	8			100	11 0283 01	...299472
	20x20x1,5	8			100	11 0284 01	...031515
	22x22x1,5	8			100	11 0287 01	...299489
	25x25x1,5	8			100	11 0285 01	...031713
	30x30x1,5	8			100	11 0286 01	...031911
	35x35x1,5	8			100	11 0289 01	...299496
	18x18x1,5	10			100	11 0189 01	...299465
	20x20x1,5	10			100	11 0184 01	...030815
	22x22x1,5	10			100	11 0187 01	...299380
	25x25x1,5	10			100	11 0185 01	...031010
	30x30x1,5	10			100	11 0186 01	...031218
	35x35x1,5	10			100	11 0188 01	...299397



	Ø mm	M x			pcs.	Code	EAN-Code 4001073 ...
	30x1,5	10			100	11 0401 01	...309317
	50x1,5	10			100	12 9950 01	...008753

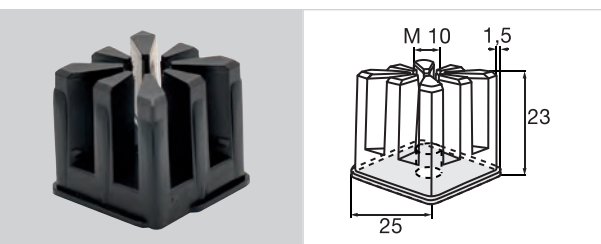

	Ø mm	M x			pcs.	Code	EAN-Code 4001073 ...
	25x25x1,5	10			100	11 0192 01	...031027



# QuickClick<sup>®</sup> PROFI-BOX

PROFI-BOX - die abverkaufsstarken Packungsmöglichkeiten

PROFI-BOX - the strong selling packaging possibilities

PROFI-BOX - les possibilités de conditionnement pour intensifier vos ventes





	Ø mm				pcs.	Code	EAN-Code 4001073 ...
					1	17 0101 01	...135268
	17	-					
	20	-					
	25	-					
	30	-					
	40	-					
	50	-					
	17	Ultrasoft					
	20	Ultrasoft					
	25	Ultrasoft					
	30	Ultrasoft					
	40	Ultrasoft					
	50	Ultrasoft					
	17	Natural					
	20	Natural					
	25	Natural					
	30	Natural					
	40	Natural					
	50	Natural					
	17	Hyper					
	20	Hyper					
	25	Hyper					
	30	Hyper					
	40	Hyper					
	50	Hyper					
	3x16	-					
	20	-					
	25	-					
	30	-					

PROFI-BOX - die abverkaufsstarken Packungsmöglichkeiten

PROFI-BOX - the strong selling packaging possibilities

PROFI-BOX - les possibilités de conditionnement pour intensifier vos ventes



	Ø mm				pcs.	Code	EAN-Code 4001073 ...
					1	17 0104 01	...301540
	17	-					
	20	-					
	25	-					
	30	-					
	40	-					
	50	-					
	17	Ultrasoft					
	20	Ultrasoft					
	25	Ultrasoft					
	30	Ultrasoft					
	40	Ultrasoft					
	50	Ultrasoft					
	17	Syno					
	20	Syno					
	25	Syno					
	30	Syno					
	40	Syno					
	50	Syno					
	17	Hyper					
	20	Hyper					
	25	Hyper					
	30	Hyper					
	40	Hyper					
	50	Hyper					
	3x16	-					
	20	-					
	25	-					
	30	-					



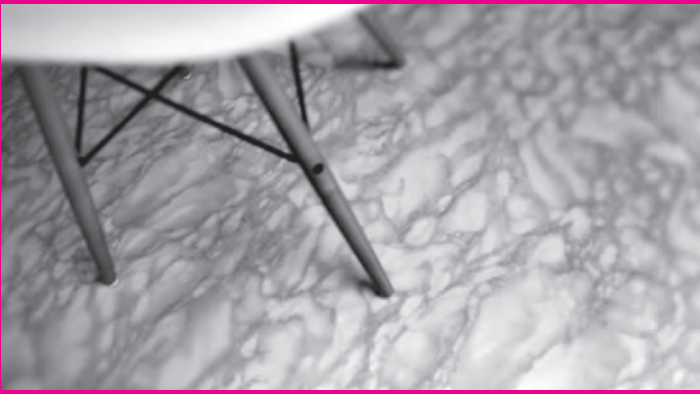



reddot design award  
winner 2013

# take care

Eigentlich ist es ganz einfach, Acht zu geben ... In „Gib Acht ...“ zeigt Filmemacher Jan Reiff, dass sich Lärm, Stress und Schaden wirksam vermeiden lassen - mit Premium-Gleitern der Marke „QuickClick®“. In rasanter Bildfolge geschnitten ist dieser Spot eine absolut eigenständige Kreativeleistung.

*Actually, it is quite easy to take care ... In “Take care ...” the film maker Jan Reiff shows, that noise, stress and damages can be avoided effectively – with premium gliders of the brand “QuickClick®”. In rapid cut pictures, this spot is an absolutely independent creative performance.*

*En fait, il est d’une grande simplicité de faire attention ... Dans « Fais attention », le cinéaste Jan Reiff démontre qu’il est possible d’éviter effectivement de bruit, de stress et de casse – avec les patins supérieurs de la marque « QuickClick® ». Avec des images rapidement coupés, ce spot est une performance absolument originale.*



„Gib Acht...“ -  
scannen & ansehen!



“Take care...” -  
scan & watch!



« Fais attention ... » -  
scannez & regardez!

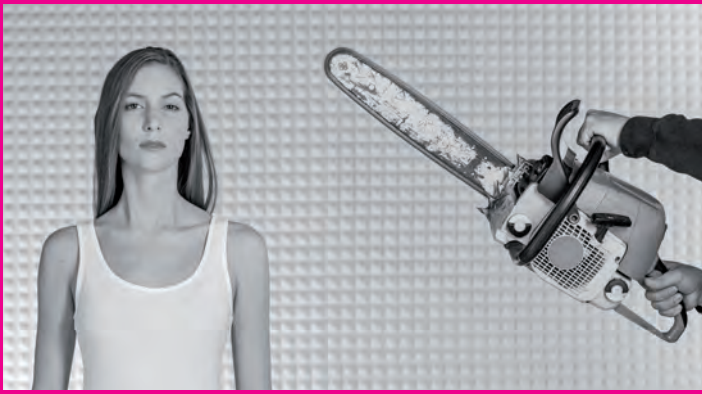



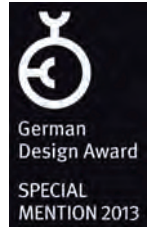

# spot on

„Scratch“ und „Dezibel“ sind Produktpots mit klarer Aussage und präziser Wirkung: Ohne den richtigen Premium-Gleiter geht nichts! Minimalistisch in Szene gesetzt von Filmemacher Jan Reiff wurde das Spot-Duo mit zahlreichen Kommunikations- und Filmpreisen international ausgezeichnet.

*“Scratch“ and “Dezibel“ are product spots with a clear message and precise action: Nothing works without the right premium glider! The spot-duo had been staged minimalist by film maker Jan Reiff and had been awarded with numerous international communication and film awards.*

*« Scratch » et « Dezibel » sont des spots de produit avec un énoncé clair et effet précise : Sans le juste patin supérieur rien ne va ! Mises en scène minimaliste par le cinéaste Jan Reiff, les deux spots ont été décorés avec nombreux prix internationaux de communication et de dessin.*



„Dezibel“ -  
scannen & ansehen!



“Dezibel“ -  
scan & watch!



« Dezibel » -  
scannez & regardez!



„Scratch“ -  
scannen & ansehen!



“Scratch“ -  
scan & watch!



« Scratch » -  
scannez & regardez!



Foto: Wassily Chair  
(Design: Marcel Breuer / Knoll International)  
Zusätzlich ausgerüstet mit QuickClick® (nicht Bestandteil des Original-Entwurfs)

*Picture: Wassily Chair  
(Design: Marcel Breuer / Knoll International)  
Additionally equipped with QuickClick® (is not a part of the original design)*

*Photo: Wassily Chair  
(Design: Marcel Breuer / Knoll International)  
Également équipé de QuickClick® (n'est pas un élément du design original)*



# *high* success

**QuickClick®** lässt Möbel und Objekte sanft und geräuschlos gleiten – und schont jede Art von Bodenbelag. Oder verhindert gefährliches Wegrutschen – und stoppt auf allen glatten Oberflächen. Ganz wie Sie wollen. Weil Sie jeden Einsatz jederzeit mit einem „Click“ austauschen können. Das ist einzigartig. Denn Perfektion beginnt im Detail. Das ist Vorsprung durch Innovation. **Für Ihren Erfolg.**

**QuickClick®** lets furniture and objects slide gently and noiselessly – and preserves every type of floor surface. Or it prevents dangerous slipping away – and stops on all smooth surfaces. Exactly how you like it. Because you exchange each insert simply with a „Click“ at any time. That is unique. As perfection starts with details. That is a lead by innovation. **For your success.**

**QuickClick®** permet à vos meubles et objets de glisser facilement et sans bruit – et protège tous types de revêtements de sols. Ou bien empêche de dangereux dérapages – et stoppe sur toutes surfaces lisses. Comme vous le désirez. Puisque vous pouvez changer chaque insert à tout moment avec un seul „Click“. C'est unique. Puisque la perfection commence en détail. Le progrès par l'innovation. **Pour votre succès.**



ULTRASOFT



SOFT



NATURAL



SYNO®



HYPER RUN



SUPER GO

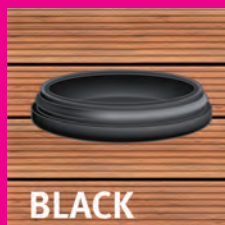

BLACK



EXTREME



STOPP STOP

*design yourself*

**Wagner System GmbH**

Tullastraße 19, D-77933 Lahr

Phone +49 (0) 7821/9477-0, Fax +49 (0) 7821/9477-60

info@wagner-system.de, www.wagner-system.de

www.quickclick.de

**WAGNER®**